

Instructions for use



CE
0051

lina

MB17 / MB22

Symbols

Symbols displayed on the product and/or used in this manual:



WARNING!
Risk of injury



ATTENTION!
To prevent damage occurring



General explanations,
without risk to persons or objects



HOT SURFACES!
Risk of burns



HOT STEAM!
Risk of burns



Call service



Thermo washer
disinfectable



Consult instruction for use



Do not dispose of
with normal waste

Contents

1. Introduction	4
2. Unpacking	6
3. Safety advice	8
4. Installation and start-up	9
5. Programming	18
6. Running a sterilization cycle	24
7. Maintenance	37
8. Troubleshooting, alarms and messages	46
9. Recycling and disposal	54

APPENDICES

1 Technical data	55
2 Maintenance of dental handpieces	56
3 Sterilization load preparation	57
4 Bowie & Dick test	59
5 Helix test	60
6 Vacuum test	61
7 Water quality	62
8 Example of a cycle data report	63
9 Accessories and spare parts	64
10 Helix test documentation form	71

1. Introduction



For your safety and the safety of your patients

The purpose of this manual is to provide you with information about LINA MB17/22 sterilizers to ensure:

- proper installation and set-up;
- optimal use;
- safe and reliable operation;
- compliance with regular maintenance and servicing requirements.



Please carefully read the safety information in Chapter 3!

Intended use of the product

Small steam sterilizers are widely used for medical purposes, e.g. in general medical practices, dentistry, facilities for personal hygiene and beauty care and also veterinary practices. They are also used for materials and equipment, which are likely to come into contact with blood or body fluids, e.g. implements used by beauty therapists, tattooists, body piercers and hairdressers.

The devices is intended for professional use only by trained people.



About this manual

All drawings, images and texts contained in this manual are the property of the manufacturer.

All rights reserved. Even partial duplication of drawings, images or text is prohibited.

The information contained in this document is subject to change without prior notice.



Responsibility of the manufacturer

The manufacturer can only accept responsibility for the safety, reliability and performance of the product when the product itself is installed, used and serviced in accordance with these instructions for use.

Servicing by unauthorized persons invalidates all claims under warranty and any other claims.

Introduction

Qualifications of the users

There are two types of users who may operate the sterilizer:

The Advanced user is the head of the clinic/practice, who is legally responsible for the efficiency of the hygiene protocol in place as well as the sterilization process. He/she is also responsible for the USERS' training and the correct operation and maintenance of the equipment.

The Users are the persons who use the sterilizer according to the ADVANCED USER's instructions. They must be trained in operating the sterilizer and in its safe use. Training must be regular and evidence of the understanding shall be recorded.

Conformity to European Standards and Directives



Medical Device Directive 93/42/CEE for devices class IIb, in accordance with the Rule 15 – Appendix IX of the above Directive.



Directive 97/23/CEE (PED – Pressure Equipment Directive) for every sterilization chamber designed and manufactured in conformity to the Appendix 1 and to the procedure described in the form D1 Annex III.



Directive 2002/96/CEE (RAEE) for disposal of parts coming from electrical or electronic products.



European standard EN13060 (small water steam sterilizers).



See the Declaration of Conformity and the Warranty Card in the enclosed documents.

2. Unpacking

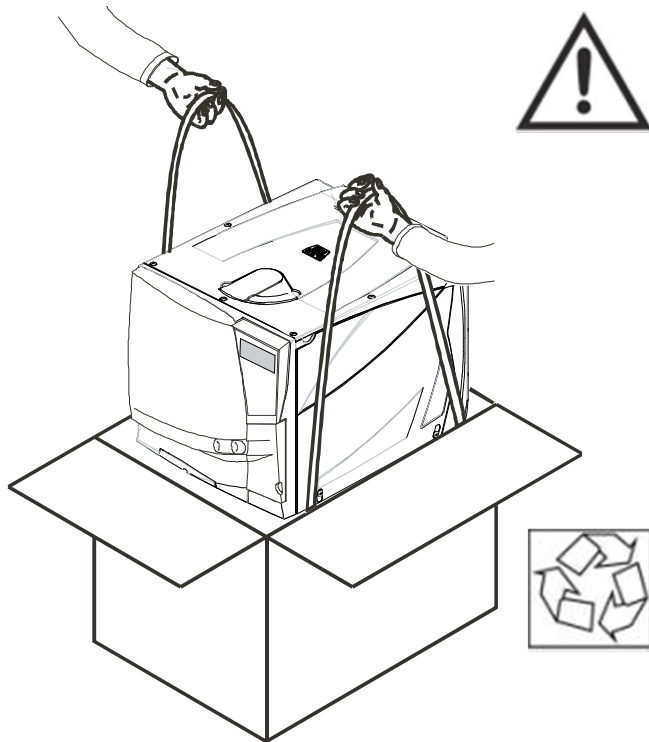

If the sterilizer comes from a cold location, wait until all external and internal surfaces are free from moisture before switching it ON.

The sterilizer must be removed from the box and transported by two people.

Weight: LINA MB17: 38 kg
LINA MB22: 40.5 kg

Check the external conditions of the box and the sterilizer. In case of any damage, immediately contact your dealer or the shipping agent that has carried out the transport.

The packaging of the product is environmentally friendly and can be disposed of by industrial recycling companies.

However, we recommend to keep the original packaging should you ever have to ship or transport the sterilizer.

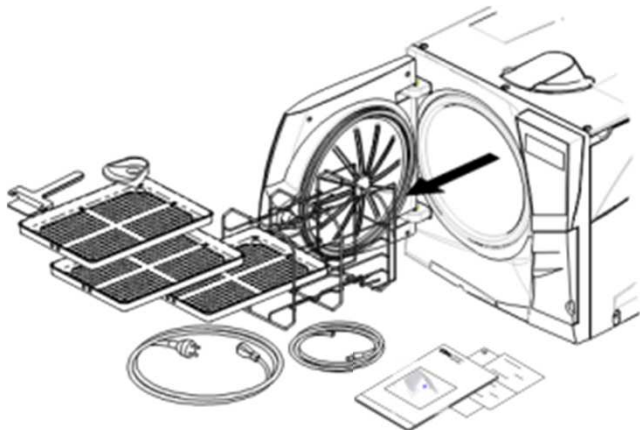

Open the front door.

All the accessories are in the sterilization chamber.
Remove all items except the trays and the tray rack.

Contents of the package

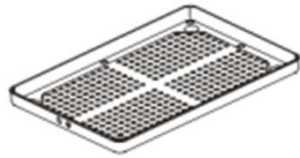

Tray (3 pieces total)

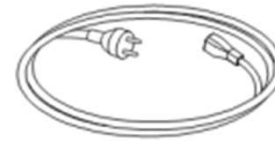

Mains cable

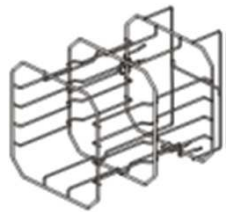

Reversible rack



Funnel



Tray holder



Wall spacer



Drain tube

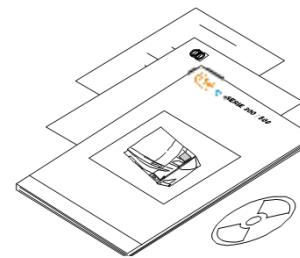

Fast guide
Declaration of conformity
Documentation CD
Warranty card
Works tests report

3. Safety advice



- The user is responsible for the proper installation, the correct use and maintenance of the sterilizer in accordance with the instructions listed in this manual.
- The sterilizer has not been designed for the sterilization of foodstuff or waste.
- Liquids may be sterilized only if the appropriate option is installed.
- The sterilizer must not be used in presence of explosive or flammable gases, vapours, liquids or solids.
- The chamber is automatically heated up to high temperature as soon as the sterilizer is switched on – risk of burns!
- Ensure that the socket the mains cable is connected to is properly grounded.
- The trays and the sterilization load will be hot at the end of each cycle. Use tray or cassette holders to empty the sterilization chamber.
- Do not exceed the maximum load weight limits as specified in this manual (see Chapter 6 of the Instructions for use).
- Do not remove the name plate or any label from the sterilizer.
- To avoid electrical short circuits, do not pour water or any other liquids over the sterilizer.
- Switch off the sterilizer and unplug the mains cable before inspecting, carrying out maintenance or servicing the sterilizer.
- The low-voltage outlet in the rear of the sterilizer is for the connection of specific accessories only: do not connect any device other than those specifically supplied by the manufacturer.
- All electric devices connected to the sterilizer shall be of Insulation Class II (double insulated) or higher.
- Repairs, maintenance or service must be carried out by service technicians authorized by the manufacturer and using genuine spare parts only.
- In case of transport:
 - Completely drain both water tanks (see section “Water Tanks” in Chapter 4 of the Instructions for use).
 - Allow the sterilization chamber to cool down.
 - Use original or appropriate packaging.

4. Installation and start-up



Placement

Place the sterilizer on a flat and level surface, far from sources of heat and from flammable materials. Do not place the sterilizer so that it is difficult to open the service door and operate on the controls in it. Do not place the sterilizer so that it is difficult to disconnect the power supply plug. Place the sterilizer in a well ventilated room. If installed in a cabinet, this shall be provided with an opening of at least 200x150 mm on the rear side. The sterilizer must not be operated in presence of explosive atmospheres.

Required minimum clearances

Back side:	50mm
Right and left sides:	10 mm
Upper side:	As required for filling the water tank, 50 mm minimum



Electrical connection

The electrical power supply to the sterilizer must fulfil all applicable standards in the country of use, and must comply with the data label on the back of the sterilizer.

Connect the cord set to the socket provided in the back of the sterilizer.

Connect the mains cable to a wall outlet with the following characteristics:

- Single - phase 200 - 240 V, 50/60 Hz, 8,75 A, on a dedicated circuit;
- Overvoltage category = II;
- 10 A differential circuit breaker with a sensitivity of 30 mA. The circuit breaker must be a certified type according to applicable norms;
- Maximum power consumption of the sterilizer is 1750 W;
- A grounded connection is essential.

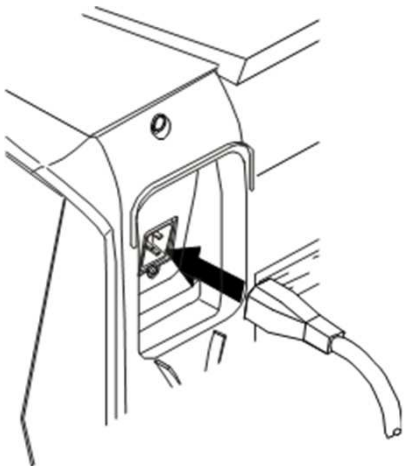

Water tanks

Filling the clean water tank

- Switch the sterilizer ON
- Slide the tank cover to the right to access the clean water tank inlet.
- Remove the cap from the tank inlet;
- Insert the funnel and fill the water tank with app. 3.5 litres of distilled or demineralized water;
- Once the clean water tank is almost full, an audible tone will sound; stop filling;
- Place the cap to close the tank;
- Slide the tank cover back into its original position.

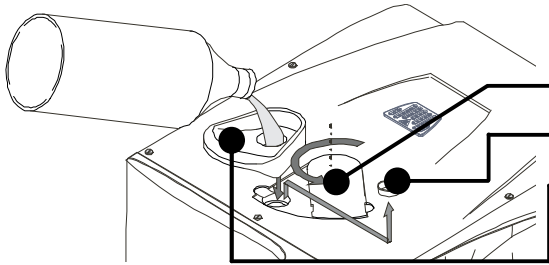

**Use only high quality distilled or demineralized water (see Appendix 7).
Do not add any chemical / additive to the water.**

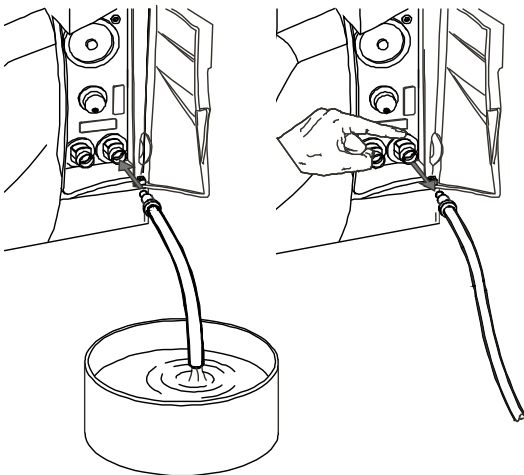

Draining the used and clean water tank

- Open the service door at the front of the sterilizer.
- Put a container (4 litres min) below the sterilizer and insert into it the free end of the drain tube.
- Insert the drain tube into the right connector (grey) for the used water, or into the left connector (blue) for the clean water.
- Let the water flow from the tank completely.
- Press the push-button on top of the quick connector to dislodge the drain tube.

Chamber furniture

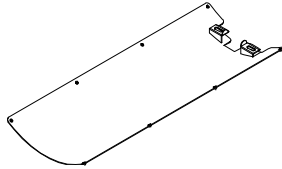
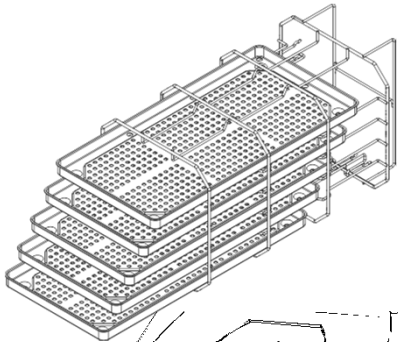

Before touching the chamber furniture, ensure the sterilization chamber is cold: risk of burns!

The chamber furniture consists of the **trays**, the **tray rack** and the **steam diffuser plate**.

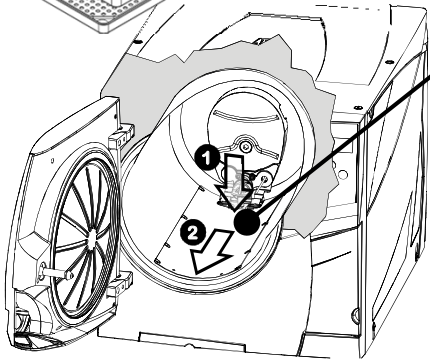

Steam diffuser plate



Ensure that the steam diffuser plate is firmly hooked in its position before starting a sterilization cycle. An improper positioning of the steam diffuser plate could result in bad steam quality and could impair the sterilization process, with risk of non sterile load and cross infection.

Sterility at the end of the cycle is not guaranteed if the steam diffuser plate was not correctly placed. **To hook** the steam diffuser plate, slide it into the chamber until it gets engaged into the end hooks. **To remove** the steam diffuser plate, press it in the center of the end edge (1) and slide it outwards (2).

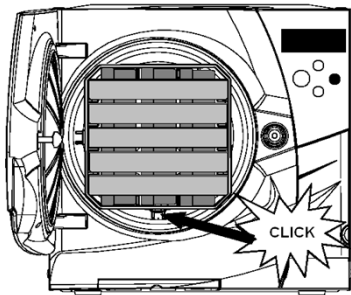

Tray rack

Insert the rack into the sterilizer chamber, align it at the center/bottom of the chamber and push it gently into position until it clicks.

The chamber rack is reversible and can accommodate 5 trays horizontally or 3 cassettes vertically.

If inserted in a 90° degree rotated position, the rack holds 3 trays or 3 cassettes horizontally.

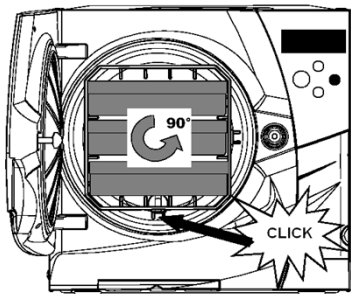

Usable space in the chamber

LINA MB17: 195 x 195 x 297mm (WxHxD); equal to the volume of 11.5 litres.

LINA MB22: 195 x 195 x 390mm (WxHxD); equal to the volume of 15 litres.

Controls and commands

Front view

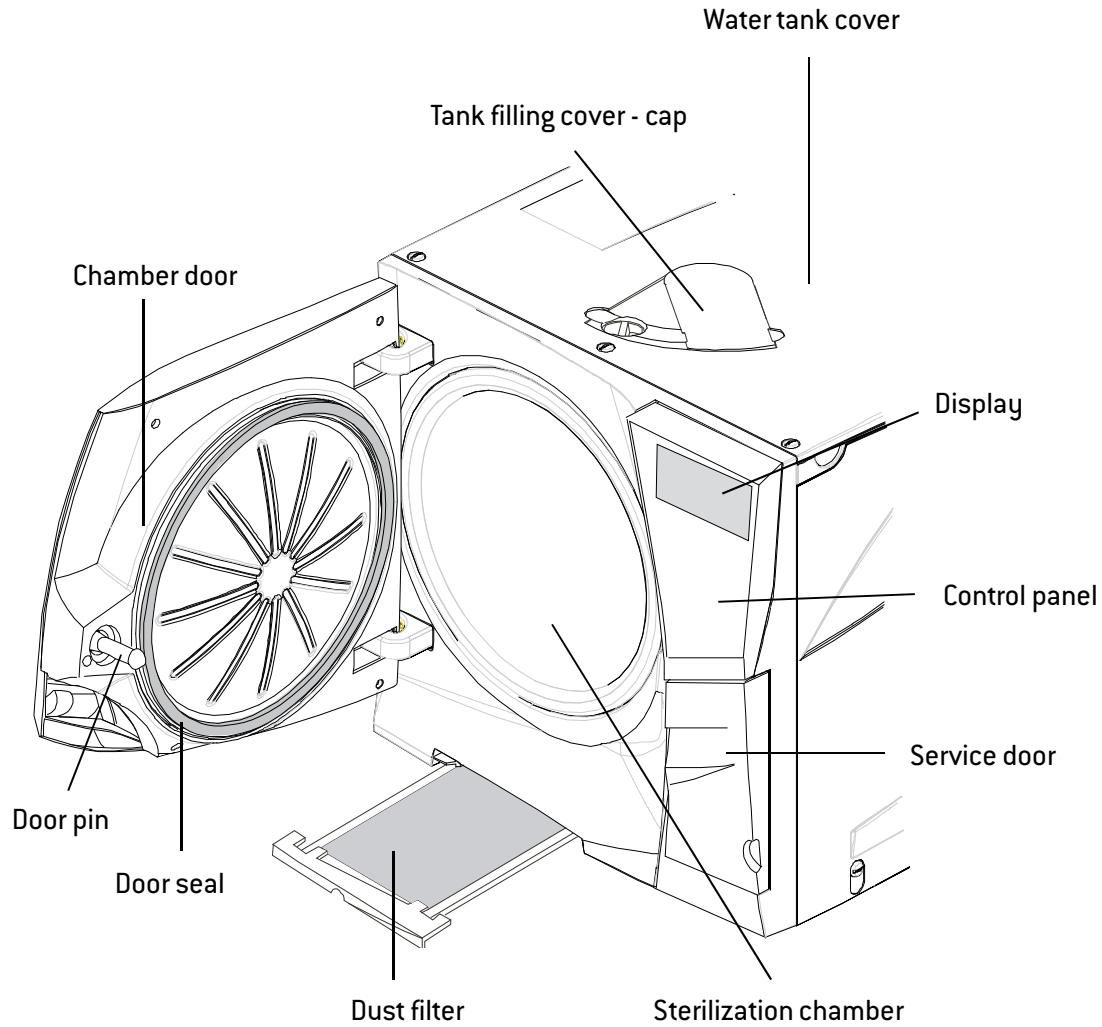

Service door

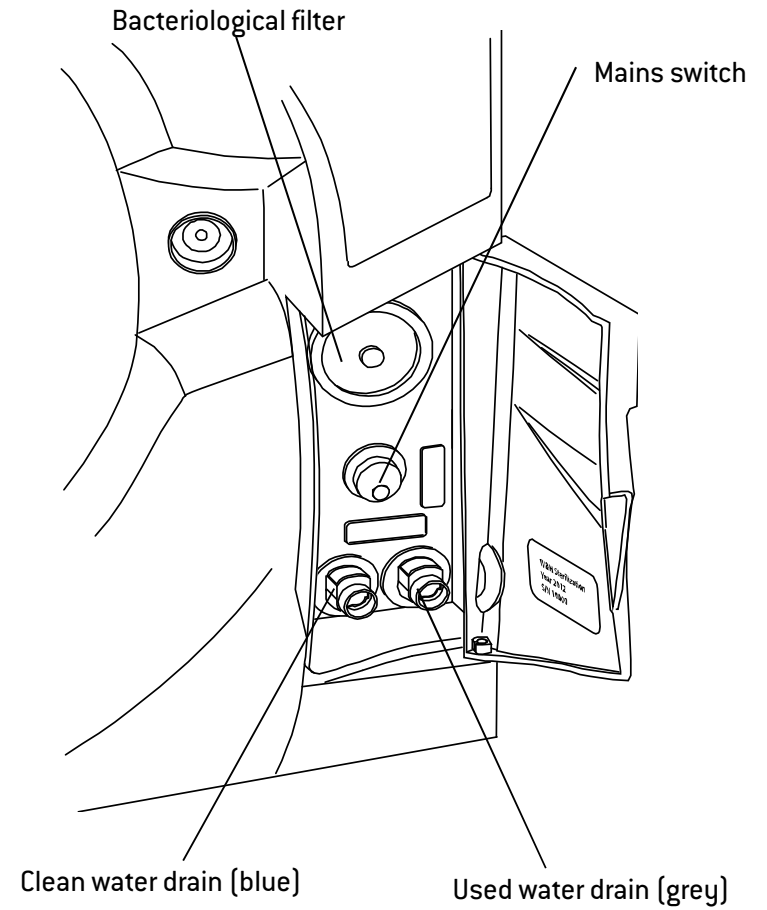

Controls and commands

Rear view

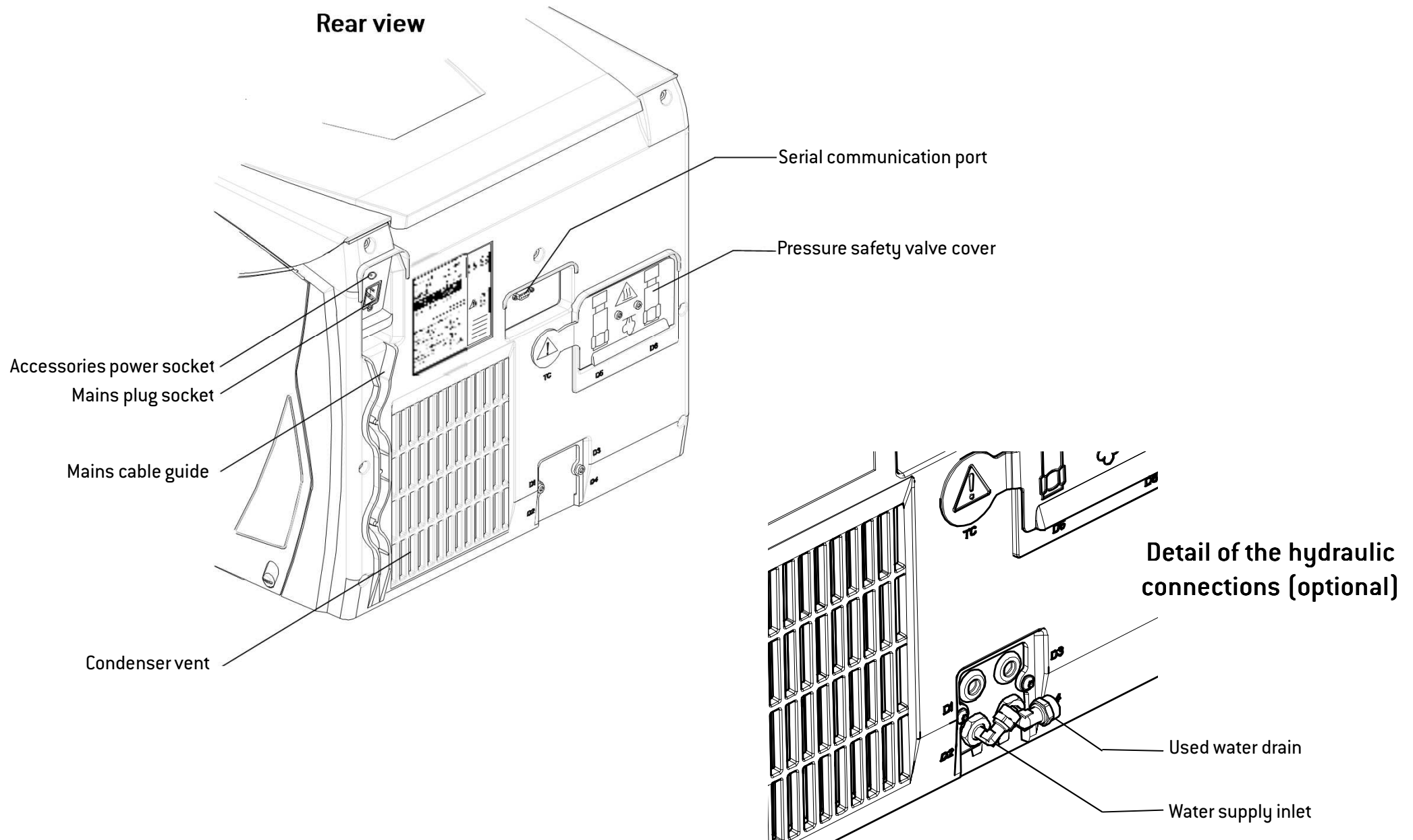

Controls and commands

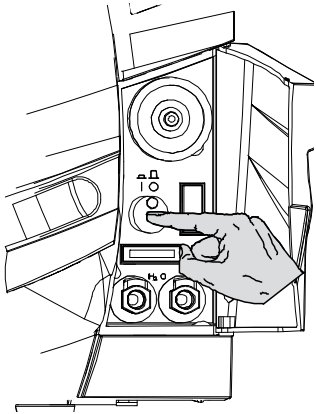

Switching ON the sterilizer

Press the mains switch behind the service door to switch ON the sterilizer.

The visual indicator on the mains switch turns green and the START screen (see next page) appears.

“SLEEP” mode

If the sterilizer is not used for 12 hours, (the time interval can be changed, see Chapter 5 - Programming) it will automatically switch to “SLEEP” mode.

In “SLEEP” mode the display remains dark and the sterilizer chamber is no longer heated to save energy.

Exit from “SLEEP” mode through any of the following actions:

- Press any button on the control panel;
- Open or (if it is open) close the chamber door.

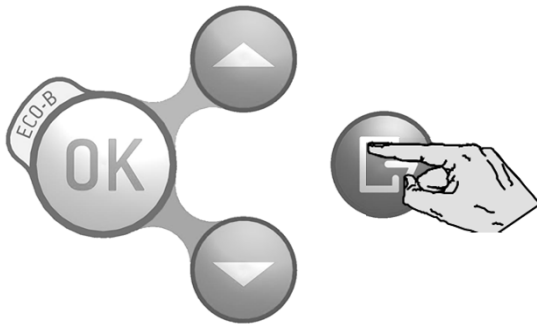

It is also possible to put the sterilizer into “SLEEP” mode manually:

On the START screen, press the BACK button.

A 10 second countdown will commence. At the end of the countdown the sterilizer will enter the “SLEEP” mode.

The countdown can be stopped at any time by pressing the BACK button.

Display and icons

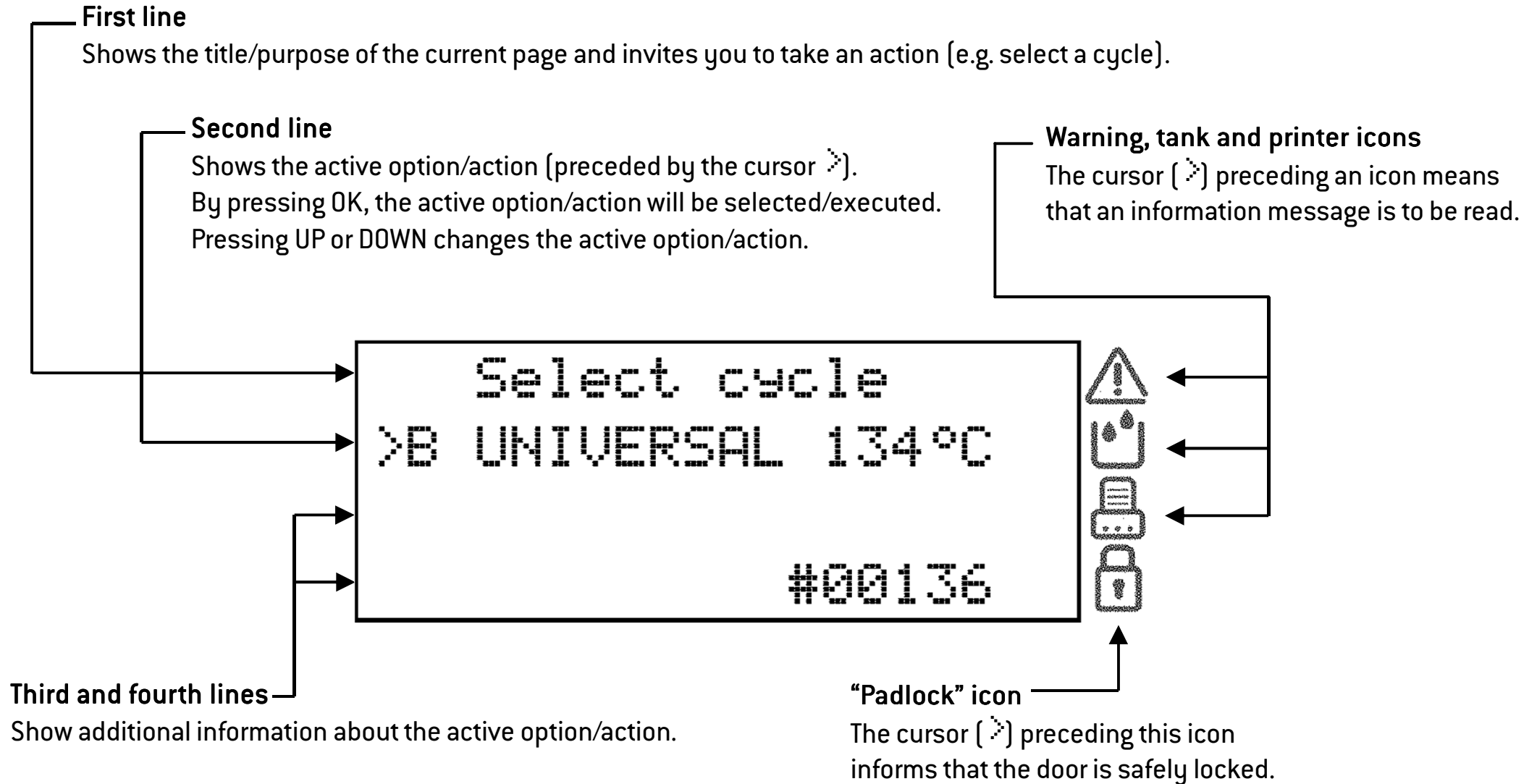

Icons

If one or more icons of the display are preceded by the cursor, please take the actions as outlined below:



If an icon is preceded by the cursor, this means that an information message is present in the MESSAGES menu. Follow the instructions provided in Chapter 8 to read the relevant messages.



General warning

One or more messages require your attention, or an action is required (e.g. maintenance).



Tank warning

The clean water tank needs to be filled, or the used water tank has to be drained, or a message about the water quality is present.



Printer

An external device (printer, PC, etc.) is not working properly, or is OFF, or is disconnected from the sterilizer.



Door locked

The door is locked. During a sterilization cycle this does not indicate any anomaly.

Control buttons

The control panel shows four buttons:

UP button

Moves to the upper item in the list.
Increases a number or a parameter.

ECO-B option

This label reminds you that, when starting a cycle, you can choose the ECO-B mode by holding the OK button for 2 seconds (see Chapter 6).

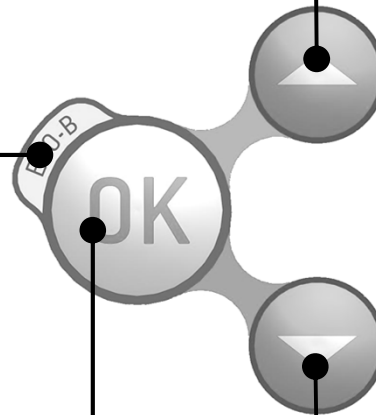

DOWN button

Moves to the lower item in the list.
Reduces/decreases a number or a parameter.

BACK button

Aborts the action/function.
Moves to the previous screen
without confirming/making any
changes nor saving any parameters.

OK button (confirmation button)

Confirms the active option.
Confirms a number or a date.
Saves a configuration or a parameter.

5. Programming

Initial setup

Before using the sterilizer please program important parameters such as date, time, language, display backlight and contrast. This is done by means of the SETUP functions.

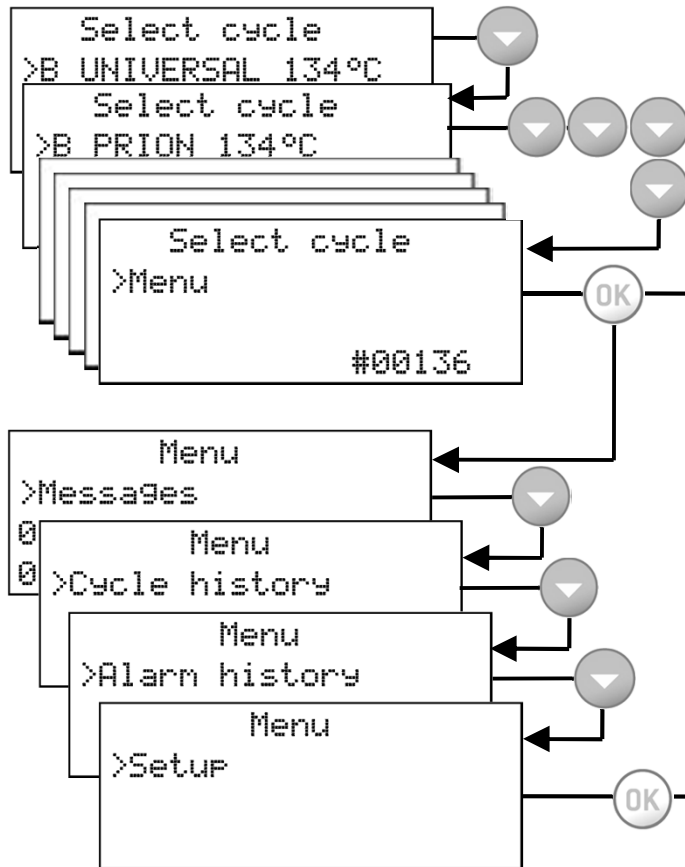

Start screen and menu options

When the sterilizer is switched ON, or when exiting from SLEEP mode, the default cycle program is displayed, preceded by the cursor.

By pressing DOWN the other available cycle programs are displayed. Continuously press DOWN until the MENU option appears.

Menu

Confirm (OK) the MENU option to access all sub-menus and navigate through sub-menus with the UP and DOWN buttons.

See the following pages for a complete description of the options available and how to use them.

Setup

Scroll (DOWN) to SETUP and confirm (OK) to access and set the main parameters of the sterilizer.

See the following pages for a complete description of the parameters you can set and how to do it.

Table 1: list of the MENU options

MENU	SUB-MENU	WHAT IT DOES			
Menu (continues on next page)	Messages	-	Displays pending messages. Refer to Chapter 8 for a detailed list of messages.		
	Cycle history	Select	Select a previously recorded cycle. Press OK and then scroll the list of the recorded cycles with UP /DOWN. Press OK to select the cycle to be viewed or printed.		
		View	Displays the selected cycle. Press UP/DOWN to scroll the cycle report.		
		Print (*)	Prints the selected cycle. Press OK and scroll UP and DOWN to change the number of copies to be printed. Once the value is displayed, press OK to print.		
		Print labels (*)	Prints traceability labels for the selected cycle. Press OK and scroll UP and DOWN to change the number of copies to be printed. Once the value is displayed, press OK to print.		
		Send HTML (*)	Saves a cycle data file on a memory storage device (memory card or PC).		
	Alarm history	View alarms	Displays all the alarms that have occurred during sterilization cycles.		
		Print all (*)	Prints all the alarms that have occurred of the sterilization cycles stored in memory.		
	Setup	Sets important parameters of the sterilizer such as date, time, language, etc. Confirm [OK] to access all available options. Refer to TABLE 2 for a detailed list of options and related programming.			
	Configuration	Aut. water supply (*)	Enables the automatic water feed	Yes	Press UP/DOWN to scroll the YES/NO options, then press OK to enable/disable the function (warning), or BACK to exit without saving.
		Ext. water sensor (*)	Enables water quality warnings based on the external/internal sensor		
		Int. water sensor (*)			
	Service	Current level	Allows the user to change the current user level. Access to advanced level or service level is protected by codes. See “How to log in as an advanced user” in the following pages.		
		Activation code	Allows the user to enter the activation code in order to enable some optional features.		

(*) available/effective only if an endorsed device (printer, logger, PC, water supply, etc.) is connected and enabled in the SETUP menu.

Table 1: list of the MENU options (continued)

MENU	SUB-MENU	WHAT IT DOES		
Menu (continued from previous page)	Print lot labels (*)	Print	Prints traceability labels to be stuck to the load pouches. Labels show the lot number and other parameters as specified in the LOT LABELS menu (see SETUP table). The number of labels will be requested: press UP/DOWN to increment/decrement the number, then press OK to print. After printing, the lot number is incremented by 1.	
		Reprint	Prints labels of a previous sterilization lot. The lot number and the number of labels will be requested: press UP/DOWN to increment/decrement the numbers, then press OK to print.	
	Device info	Brand	Displays the device brand name; e.g. W&H.	
		Model	Displays the device model name; e.g. LINA MB22.	
		Serial number	Displays the serial number of the sterilizer; e.g. 110009.	
		Performed cycles	Displays the total number of cycles executed by the sterilizer.	
		Service counters	Dust filter	Displays the status (number of cycles executed) of consumables. Permits the user to reset the counter to zero after replacing a consumable. See Chapter 7 (Maintenance) for details.
			Bac. filter	
			Door seal	
			4000 service	Displays the number of cycles executed compared to the 4000 cycle service.
			20000 service	Displays the number of cycles executed compared to the 20000 cycle service.
		Software rev.	Displays the current software version.	
		Boot version	Displays the current system software version.	
		Power version	Displays the current version of the power firmware.	
HW key ID	Shows the identifier of the hardware key (label printer/service), if connected.			
PC/logger version	Displays the software version of the PC/logger device, if connected.			

(*) available/effective only if an endorsed device (printer, logger, PC, water supply, etc.) is connected and enabled in the SETUP menu.

Table 2: Detail of the SETUP options

MENU	SUB-MENU	WHAT IT DOES AND HOW TO SET IT	
Setup (continues on next page)	Language	Sets the language. The active language is displayed: press OK and scroll other available languages with UP or DOWN. When the new language is displayed press OK to confirm, or BACK to exit without saving.	
	Date and time	Date format	Sets the date and time display formats. Press OK to access the function and then scroll with UP and DOWN until the preferred format is displayed. Press OK to confirm. Press BACK to exit without saving.
		Time format	
		Set date and time	Sets the time and date which will be used for the cycle report and for the delayed cycle start option. By pressing OK the cursor is positioned on the date. Change the month, year and the day with UP or DOWN. By pressing OK, the changes are saved and the cursor moves to the time setting. The procedure for setting the time is the same. During the procedure, you can press BACK to return to the SETUP menu without saving.
	User name	Sets the operator or dental clinic name which will be used for the cycle report. There are 18 characters [capital letters and numbers] plus space, the dash and the point. You can store only one name. By pressing OK the saved name is displayed, or a series of dashes if no name is saved. Press UP and DOWN to change characters. Press OK to save a character and the cursor will move to the next character. To return to the previous character, press BACK. To go to the next character without changing it, just press OK without pressing either UP or DOWN. To go to the last character hold OK for two seconds. Press BACK on the first character to exit without saving. Press OK on the last character to save the name as displayed.	
	Sleep mode	Sets the time before the sterilizer will enter "SLEEP" mode. In "SLEEP" mode the sterilizer consumes less energy. It is advised to set a short "SLEEP" mode time in order to save energy. See Chapter 4 "CONTROLS AND COMMANDS" for a description of "SLEEP" mode. Press OK to view the current time. Press UP or DOWN to increase or decrease the time by increments of 10 minutes from 10 minutes to 12 hours. Press OK to save the time. Press BACK to exit without saving.	
	Volume setting	Increases or decreases the sound volume. Press OK to view the current setting. To decrease or increase the volume press UP or DOWN: a sound will be emitted as an example. Press OK to save the new setting. Press BACK to exit without saving.	
	Display contrast	Sets the display contrast. Press OK to view the current setting. Press UP to increase or DOWN to decrease the contrast. Press OK to save the new setting, or BACK to exit without saving.	
Serial port	Sets the device that is connected to the serial port. See note [*] for setting instructions.	Not used	Serial port not in use.
		Printer	Serial port used for cycle report printer.
		Label printer	Serial port used for label printer (available only if a label printer is present and configured).
		PC/logger	Serial port used for an external PC/LOGGER (see APPENDIX 9 – Accessories).

Table 2: Detail of the SETUP options (continued)

MENU	SUB-MENU	WHAT IT DOES AND HOW TO SET IT		
Setup (continued from previous page)	Printer settings	Printer model	Sets the printer model	
		Printer baudrate	Sets the speed of the printer port	
	Preheating (**)	Sets the preheating mode See note (*) for instructions	Door closed	Preheats the chamber ONLY if the chamber door is closed.
			Never	Chamber is never preheated.
	Hot surf. warning (**)	Sets the HOT SURFACES warning See note (*) for instructions	Yes	A warning appears while the door is open and the chamber hot.
			No	No warning appears.
	PC/logger warning (**)	Sets the PC/LOGGER warning See note (*) for instructions	Yes	A warning appears if the PC/LOGGER is not detected or if data saving fails.
			No	No warning appears.
	Units (**)	Pressure	Sets the unit for pressure	See note (*) for instructions.
		Temperature	Sets the unit for temperature	
	Cycle reports	Autom. printing (*)	Enables automatic printing of the cycle report.	
		HTM2010 option (**)	Enables printing the plateau temperature at fixed time steps (use the next option to set the step).	
		HTM2010 step (**)	Sets the time step and enables printing the plateau temperature at the set time interval.	
	Label printer (**)	Model	Sets the label printer model See note (*) for instructions	
		Horizontal offset	Set the horizontal and vertical offsets of the label layout. Adjust the values according to note (*), until the printout is properly centred in the label	
		Vertical offset		
	Cycle labels (**) (***)	Autom. printing (*)	Sets the number of labels to be printed automatically at the end of each successful sterilization cycle.	
		Manual printing	Yes	The user will be asked for the number of labels to be printed at the end of each successful sterilization cycle. Press UP/DOWN to increase/decrease, OK to confirm. Press BACK to exit without printing.
			No	The pre-set number of labels (see "AUTOMATIC PRINTING") will be printed at the end of each successful sterilization cycle, with no further request for manual printing.
	Lot labels (**) (***)	Expiry time (*)	Sets the expiry time (to be programmed in weeks) for labels. The software will automatically add the programmed expiry time to the current date and print it on labels. If it is set to zero, no expiry date will be printed on labels.	
Set counter (*)		Sets the lot number to be printed on the labels (it will be increased at each lot).		
Label fields (*)		Sets the information (user name, time/date, expiry date) to be printed on the labels.		

Note (*) The current setting is displayed: press OK to enable changes and then UP/DOWN to scroll the available options. Press OK to set a new option, or BACK to exit without saving.

Note ()** This option is available for advanced users only. See the next page for instructions about how to log in as an advanced user.

Note (*)** This option is available only if a compatible label printer is connected.

How to log on as an advanced user

Some programmable options of the LINA MB sterilizer can be changed only after logging in as an advanced user. This is to prevent accidental changes or unexpected operation of the sterilizer. Hiding a cycle program, making it inaccessible to users, is an example of option that can be accessed by advanced users only.

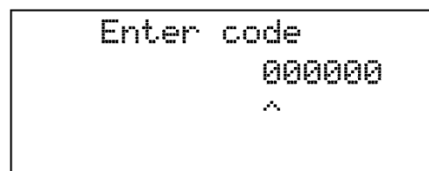
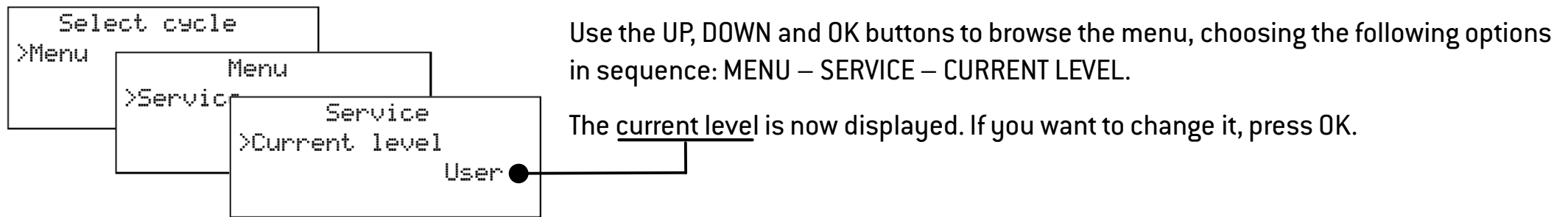

The screen as shown to the left will appear: you can now type in the advanced user code (000123) using the UP, DOWN, BACK and OK buttons as follows:

- UP/DOWN to increase/decrease the current number (indicated by the cursor `^`);
- OK to save the number and move to the next one;
- BACK to move to the previous number.

Press OK on the LAST number to confirm the code .
Press BACK on the FIRST number to abort the procedure.

After making the desired changes in the advanced user level, return to the user level by setting all numbers to zero, or switch OFF the sterilizer and then ON again.

6. Running a sterilization cycle

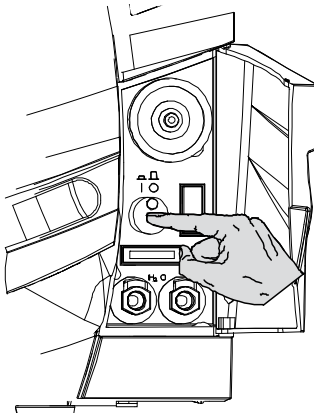

Place the sterilization load in the sterilizer chamber and close the door.



See APPENDICES 2 and 3 on how to properly prepare and place the load.

Switch the sterilizer ON by pressing the mains switch behind the service door.

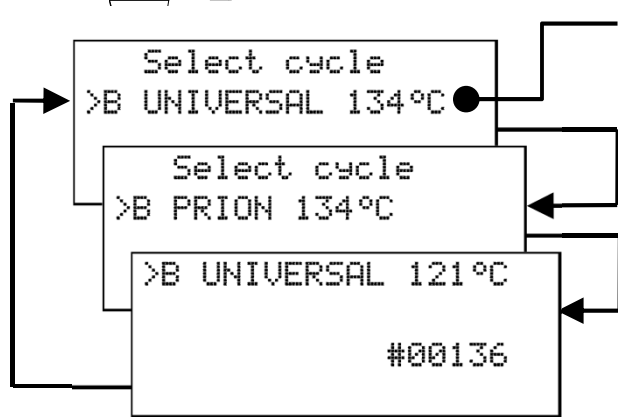

The start screen will show the default sterilization program, preceded by the cursor.
(The default cycle program can be changed by the advanced user; see Chapter 5 – Programming).

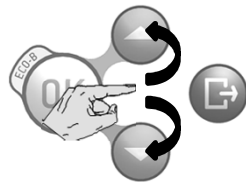

To select a different cycle program scroll the available options by pressing UP or DOWN.

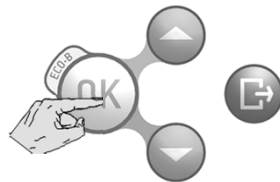
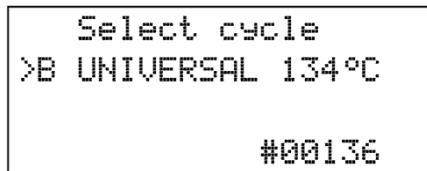

Select the desired cycle program by pressing OK.

To start the cycle in ECO mode, hold the button for 2 seconds (see page “The ECO-B option in this Chapter”).

Running a sterilization cycle

After selecting the cycle:

- the first line of the display shows the selected cycle.
- the "START NOW" option appears: press **OK** to start the sterilization cycle immediately, otherwise see the next pages for the "delayed start" options.
- the third and fourth lines show the maximum load weight limits for the selected cycle.
- if you want to select a different cycle, press **BACK** to return to the cycle selection screen (see previous page).

```
B UNIVERSAL 134°C
>Start now
Max. 5kg instr.
Max. 1.8kg textile
```

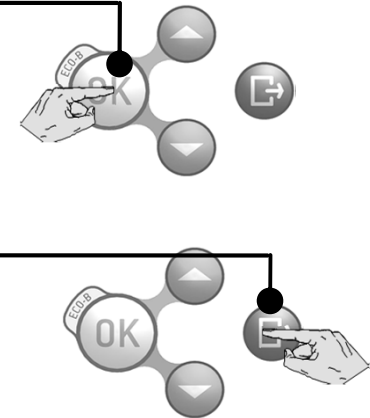

After initiating the cycle:

- the door locks automatically (the cursor appears near the "padlock" icon);
- the sterilization cycle starts;
- the second line shows the approximate residual cycle time;
- the third and fourth lines show the "Cycle-in-progress" information (see "Cycle in progress" in the following pages of this chapter)

```
B UNIVERSAL 134°C
> 42:00
T: 22.5°C PV1
P: 0.00bar #00136 >
```



See the following pages for a description of each cycle program (temperatures, times, maximum load weights).

The available sterilization cycles

In total there are three sterilization cycles available. All cycles are type B according to the European Standard EN13060, which means they are capable to sterilize all types of loads: full solid, porous, hollow A and B, plastics, rubber, etc.; unwrapped, bagged, single or double wrapped.

Select B UNIVERSAL 134°C cycle for all your general items like hand instruments, handpieces, forceps, etc.

Select B PRION 134°C cycle if a 18 minute sterilization plateau time is required for your load or mandated in your country.

Select B UNIVERSAL 121°C cycle for all items that cannot withstand the high temperatures of the 134 cycles, such as textiles and plastics.



For your safety and the safety of your patients

Never exceed the maximum load weight limits as specified in the cycle program table (see next page) as this could impair the sterilization process.

The available sterilization cycles

CYCLE PROGRAM TABLE				
Model		Lina MB17	Lina MB22	
Max. load (instruments)		4 kg	5 kg	
Max. load (porous)		1.5 kg	1.8 kg	
CYCLE PROGRAM NAME	Plateau		Total cycle time ⁽⁶⁾ (Drying time) ⁽³⁾ minutes	Total cycle time ⁽⁶⁾ (Drying time) ⁽³⁾ minutes
	Temperature °C	Time ⁽²⁾ minutes		
B UNIVERSAL 134°C	134	3,5	59 (25)	72 (30)
B UNIVERSAL 134°C ECO MODE ⁽¹⁾	134	3,5	25 (7)	28 (7)
B PRION 134°C ⁽⁴⁾	134	18	74 (25)	87 (30)
B PRION 134°C ⁽⁴⁾ ECO MODE ⁽¹⁾	134	18	40 (7)	43 (7)
B UNIVERSAL 121°C ⁽⁵⁾	121	15	67 (30)	81 (30)

(1) 0,5kg instruments single wrapped, warm start (no textile)

(2) values could be different depending on country requirements

(3) the drying time can be increased: see “Customization of cycle parameters” in Chapter 6

(4) Cycle name could be different depending on country requirements

(5) Time specified for textile load

(6) The total cycle time may vary depending on the type of load (solid or porous), the load weight, and other factors.

The sterilization cycle profile

All available sterilization cycles feature the same basic pressure profile as shown in the graph below.
The duration of the sterilization phase (or plateau time) and the sterilization temperatures differ between the various cycles.

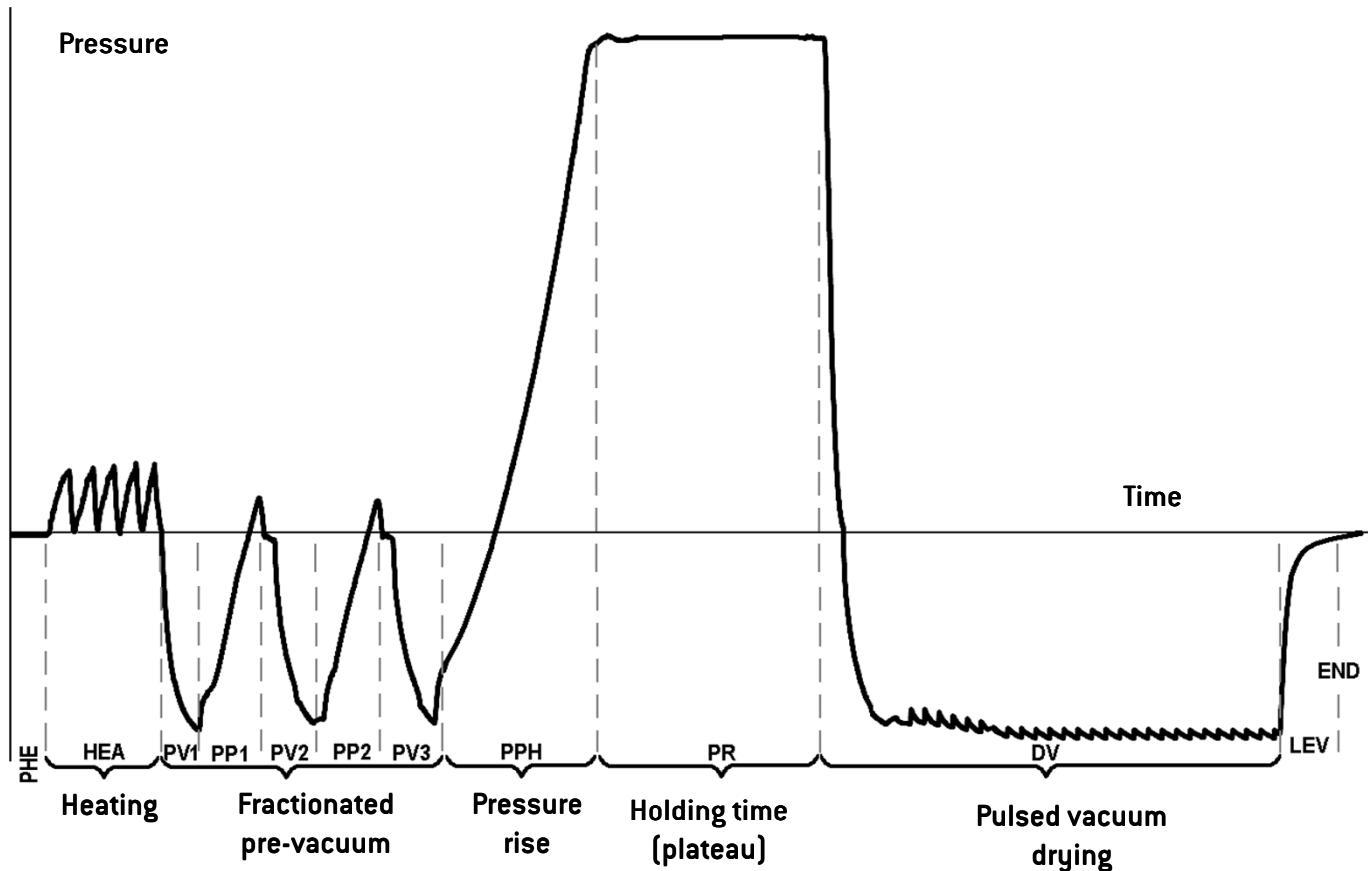

LEGEND	
PHE	Pre-heating (this is not considered a part of the cycle)
HEA	Heating
PV1 - PV3	Vacuum pulse (removal of air from the sterilizer chamber/load)
PP1 - PP2	Pressure pulse (steam generation)
PPH	Rise to the sterilization phase
PR	Process (plateau/sterilization time)
DV	Vacuum drying
LEV	Leveling
END	End of the cycle

The ECO-B option

“ECO-B” is a cycle option designed to reduce the cycle duration and the overall energy consumption, providing a fast type B cycle for a limited load weight (0.5 kg of instruments only!).

The “ECO-B” option is available for the B UNIVERSAL 134°C and B PRION 134°C cycles only.

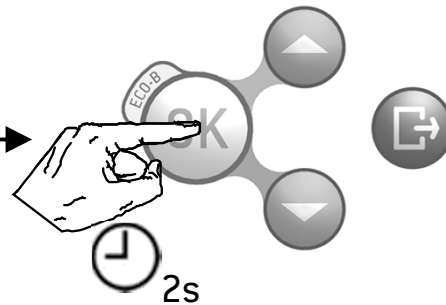
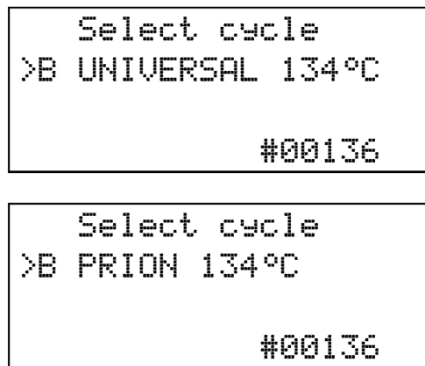

To start a cycle in the ECO-B mode, select the cycle and then confirm your selection by **holding the OK button for two seconds.**

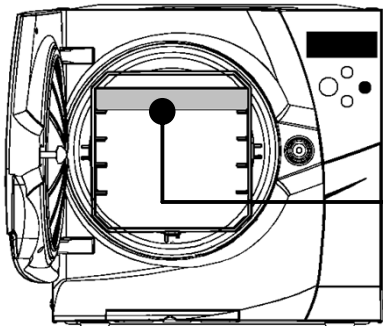

Loading the chamber when running an ECO-B cycle

In ECO-B mode, the maximum load weight limit changes to 0.5 kg of instruments only!

Always place items on the upper tray of the chamber rack and remove all other trays from the chamber. Ensure that the paper side of sterilization bags faces up.



For your safety and the safety of your patients

Never exceed the maximum load weight limits as this could impair the sterilization process.

The “Delayed start” options

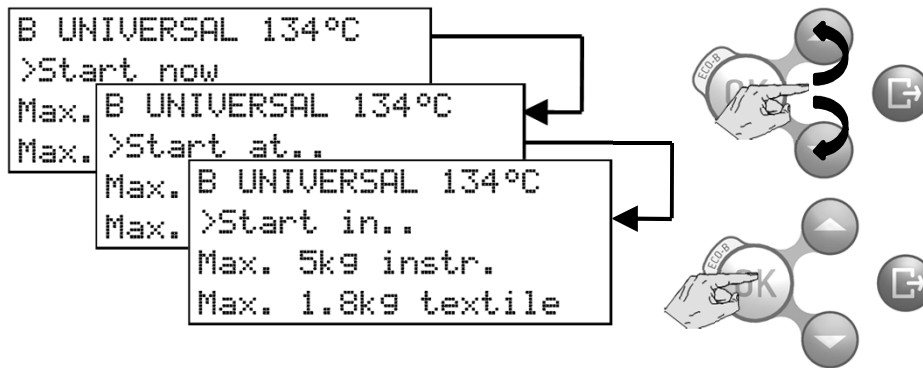

After selecting a cycle program, press UP or DOWN to scroll between the “start now”, “start at...” and “start in...” options.

Select the desired option by pressing OK.



The delayed start option is not available for all cycles.

“Start at...” option

Sets the time and date when the cycle starts.

Press OK: the display shows the last choice. If you accept it press OK, otherwise press UP or DOWN and then OK to select “Set start at...” to set a new time/date: by pressing UP, DOWN and OK you can change the time/date. Press OK to confirm the change. The cycle will start at the indicated time. A countdown timer will appear on the display.

Press BACK at any time to abort the procedure.

“Start in...” option

Sets a waiting interval before the cycle starts by increments of 10 minutes, up to 24 hours.

Press OK: the display shows the last interval used. Press UP or DOWN and then OK to select “Set start in...” to set a new interval.

By pressing UP and DOWN you can change the time interval. Press OK to confirm the change. The cycle will start after the programmed interval. A countdown timer will appear on the display.

Press BACK at any time to abort the procedure.

Stopping the countdown

During the countdown, you can press UP and DOWN to scroll between the two following options:

Start now	Press OK to stop the countdown and start the cycle immediately
Stop	Press OK to stop the countdown and return to the main menu (a further confirmation will be requested)

Customization of cycle parameters

You can customize a cycle program by setting certain parameters according to your own sterilization protocol. The parameters you can set are the drying time, the plateau time, and the plateau temperature (see note[*] below).



Changing the plateau time and temperature

It is strongly recommended not to decrease neither the plateau time nor the plateau temperature, as these are sterilization parameters that shall comply with stringent requirements of legal, regulatory and scientific nature.



Changing the drying time

The duration of the drying time can be increased or decreased according to the characteristics of the load. When changing the drying time, ensure that the load is always dry at the end of a sterilization cycle in order to avoid wicking of moisture and, potentially, microorganisms from hands, gloves or environmental surfaces.

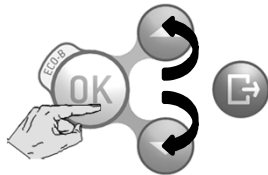
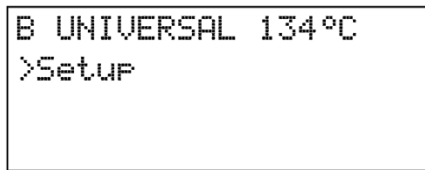

After selecting a cycle, press UP or DOWN until the SETUP option appears and confirm (OK). Scroll the sub-menu options by pressing UP or DOWN (the current value is displayed) and follow the instructions in the table below.

MENU	SUB-MENU	WHAT IT DOES AND HOW TO SET IT	
Setup	Set as default*)	Yes	Sets the cycle as the default cycle , means it will appear first on the start screen. After pressing OK, press OK on YES to set the cycle as the default cycle (the other cycles will be automatically set to NO); press BACK to exit without saving.
	Hide (*)	Yes	Unhides/hides a cycle. Once a cycle is hidden, it will no longer be visible in the menus and thus it will be impossible to launch it.
		No	After pressing OK you can scroll between YES and NO with the UP and DOWN buttons. Press OK on YES to hide the cycle, press OK on NO to unhide it, press BACK to exit without change.
	Sterilizat. temp. (*)	Sets the plateau temperature.	
	Sterilizat. time (*)	Sets the duration of the plateau phase.	
Drying time (*)	Sets the duration of the drying phase.		
		After pressing OK, an asterisk will appear near the current value, indicating that it can be changed by pressing UP or DOWN. After programming the desired value, press OK to confirm or BACK to exit without saving.	

[*] The parameters that you can actually change depend on the country of use, the model of the sterilizer and the access level.

Cycle in progress

Information displayed on the screen while a cycle is in progress

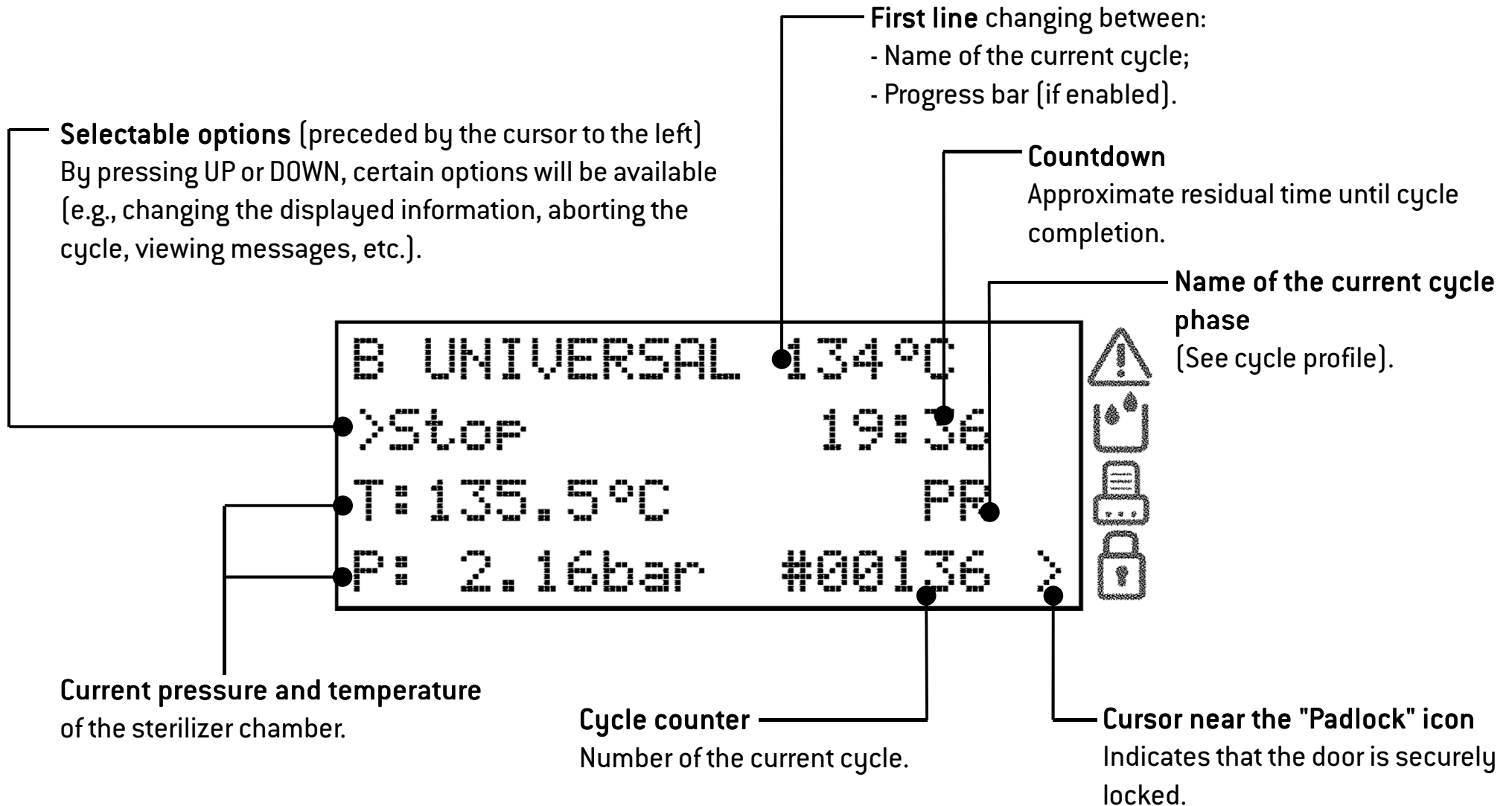

Cycle in progress

INFO screen and menu options

While a cycle is in progress, you can view the main cycle parameters in real time.

On the “cycle in progress” screen, press UP or DOWN until the INFO option appears. Other menu items are also available at this stage.

```

B UNIVERSAL 134°C
>Info
T:135.5°C      PR
P: 2.16bar    #00136 >
    
```

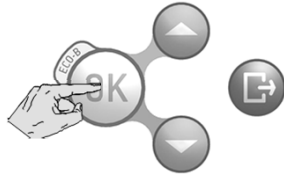

Then confirm with OK.

```

          Info
Cycle      10:13
Phase      0:13
The        135.5°C >
    
```

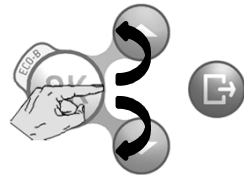

The current parameters of the cycle in progress are displayed.

Press UP or DOWN to view the complete list of values (see table below).

Press BACK to return to the standard “cycle in progress” screen.

Screen title	Info	
Cycle time	Cycle	0:00
Phase time	Phase	0:00
Heating element temperature	The	40.25°C
Steam pressure	P1	0.65bar
Temperature in the chamber	Tst	40.25°C
Heating element power output	Power-he	865W
Theoretical temperature	Tth1	40.25°C
Additional chamber sensor temperature	T6-EPIN	40.25°C
Mains voltage	V. mains	229.12V
Mains frequency	F. mains	50Hz
Total water injected	H2O	57cc
Water conductivity	H2O	9.2uS

Legend of the parameters displayed when scrolling the INFO screen.

Manual stop

While a cycle is in progress, you can abort it manually at any time.

Press UP or DOWN until the STOP option appears preceded by the cursor, then proceed as shown below:

```
B UNIVERSAL 134°C
>Stop 18:27
T: 135.5°C PR
P: 2.16bar #00136 >
```

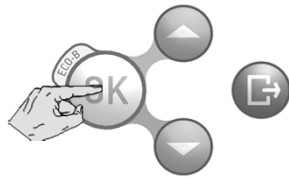

Confirm STOP (OK)

```
B UNIVERSAL 134°C
>No
Do you really want
to stop the cycle? >
```

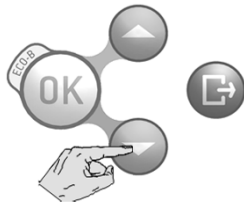

Press DOWN until YES appears.

```
B UNIVERSAL 134°C
>Yes
Do you really want
to stop the cycle? >
```

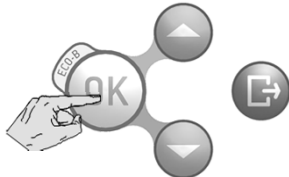

Confirm (OK) YES



Before the cycle abortion is confirmed, the abortion procedure can be interrupted at any time; press BACK several times until you get to the “cycle in progress” screen and the cycle will go on as originally programmed.

```
Manual Stop.. Plea
>Info
T: 78.9°C E990
P: -0.31bar #00136 >
```

Once a cycle is aborted, a reset phase commences to safely release any steam pressure from the chamber. This may take several minutes. Do not switch off the sterilizer! Wait until the reset phase is completed.

At this stage you can access some menu items by pressing UP or DOWN.

When selecting the INFO option (see picture) you can view the sterilizer parameters in real time (see previous page).

Manual stop

```
B UNIVERSAL 134°C
Manual stop E990
Press "back icon" >
```

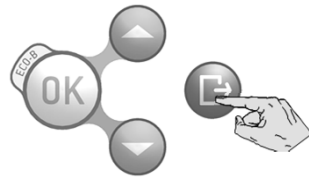

When the reset phase is over, press BACK



One of the following messages appears:

```
B UNIVERSAL 134°C
>Unlock door
Manual stop E990
Load not sterile
Ster.cond.achieved
drying interrupted
```

The message "LOAD NOT STERILE" means that the load is not sterile. Do not use items on patients!

The message "DRYING INTERRUPTED" means that the load might be wet. Wet items are for immediate use only!

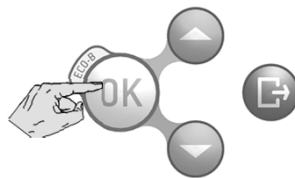

Press OK to unlock the door as requested in the second line of the screen.

(a waiting message appears while the door is unlocking)

```
B UNIVERSAL 134°C
Open door!
```

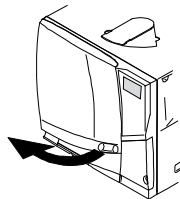

Open the chamber door and remove the load, or repeat the sterilization cycle.

End of a sterilization cycle

```
B UNIVERSAL 134°C
>Unlock door

Cycle completed >
```

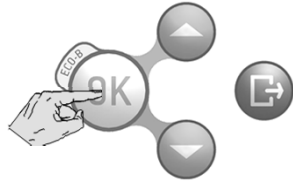

```
B UNIVERSAL 134°C

Open door!
```

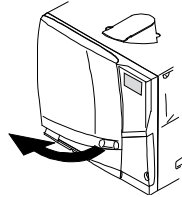

```
B UNIVERSAL 134°C
>Unlock door
End of alarm E331
Load not sterile >
```



When a cycle is successfully finished, the “CYCLE COMPLETED” message appears on the screen and the “Unlock door” option is preceded by the cursor.

At this stage you can press DOWN or UP until the INFO option appears; confirm INFO to access cycle parameters for mechanical sterilization monitoring (see previous pages).

This is only possible prior to unlocking the chamber door.

Confirm (OK) to unlock the door (the cursor near the “padlock” icon disappears).

Wait the door to unlock, then open the chamber door.

If an alarm message appears at the end of the cycle, consult Chapter 8 (Troubleshooting) of the Instructions for Use and, if the problem persists, call for technical service.

Remove the load from the chamber.



WARNING! THE LOAD AND THE STERILIZER ARE HOT!

Use the tray holder (or cassette holder) to remove the load!

Do not touch the chamber, the inner porthole and the internal fittings as long as they are hot.

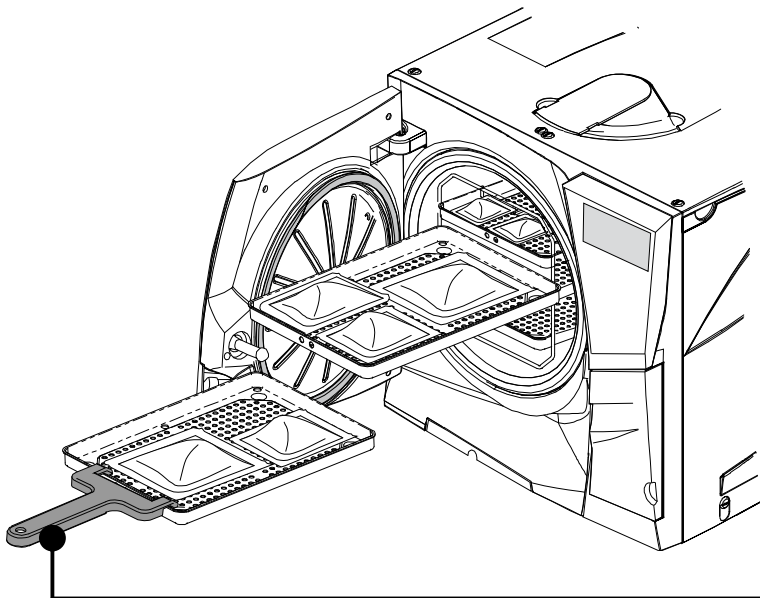

7. Maintenance



Before carrying out any maintenance on the sterilizer, switch the unit OFF and remove the mains cable.



Before accessing the chamber and the connected parts, be sure that the sterilizer is cold.



Follow the instructions in this chapter when carrying out any maintenance on the sterilizer.

Maintenance program

The maintenance program is outlined in the table on the next page.

It includes the replacement of certain wearing parts (consumables) which is imperative to ensure the safe and faultless operation of the sterilizer.

Maintenance counters

The sterilizer keeps track of the age of consumables by keeping memory of the number of cycles executed since the last replacement.

When one counter reaches the maximum, a replacement message appears on the screen and the consumable needs to be replaced; replace the consumable.

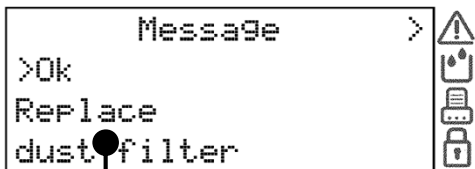

Maintenance program

MAINTENANCE PROGRAM TABLE								
Frequency (*)	# of cycles (*)	Operation	Consumable	Performed by				
Monthly	50	Clean the door seal and the chamber face side	See APPENDIX 8	User				
		Clean the chamber, trays and the rack						
		Clean the chamber filter						
		Clean the external sterilizer surfaces						
		Clean the steam diffuser plate						
3 months	400	Replace the bacteriological filter			See APPENDIX 8	User		
		Replace the dust filter						
6 months	800	Clean both water tanks					See APPENDIX 8	User
Yearly	800	Replace the door seal						
5 years	4000	General check and service						
-	20000	General check and service						

(*) whichever occurs first

Monthly or 50-cycle maintenance

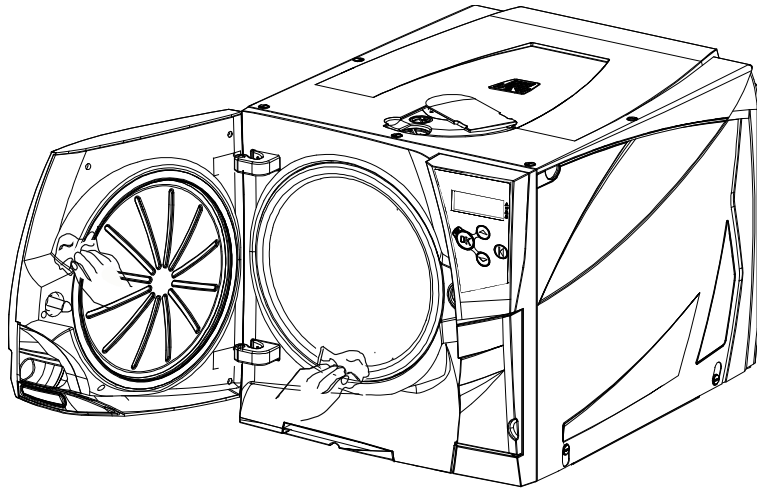

Cleaning the door seal and the chamber face side

Clean the door seal and the outer edge of the chamber with a non-abrasive cloth moistened with water. If you use a detergent solution, be careful not to get in contact with the plastic body of the front cover.

Rinse with clean water.

Do not use abrasive products, cutting tools or sharp objects.

Cleaning the chamber and the chamber accessories

Remove the trays from the chamber.

Remove the chamber rack and the steam diffuser plate.

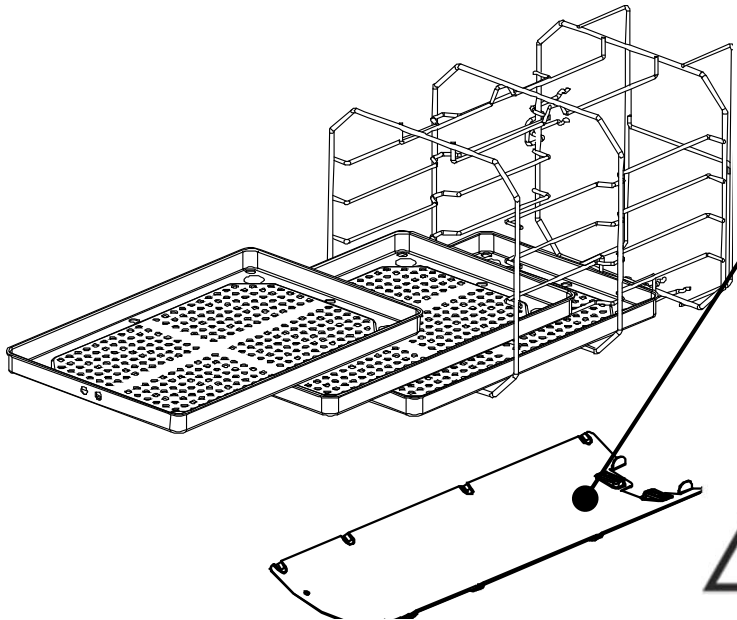

Clean the chamber with a damp sponge and a mild detergent solution paying attention not to bend or damage the temperature probe inside the sterilizer chamber. Rinse with water.

Clean the steam diffuser plate, the trays and the tray rack with a damp sponge and a mild detergent solution. Rinse with water.

Reposition all pieces of the chamber accessories properly.

Ensure that the steam diffuser plate is correctly placed and engaged, as this is essential for the sterilization process.



The trays, the tray holder and the steam diffuser plate may also be cleaned in a washer disinfectant.

Monthly or 50-cycle maintenance

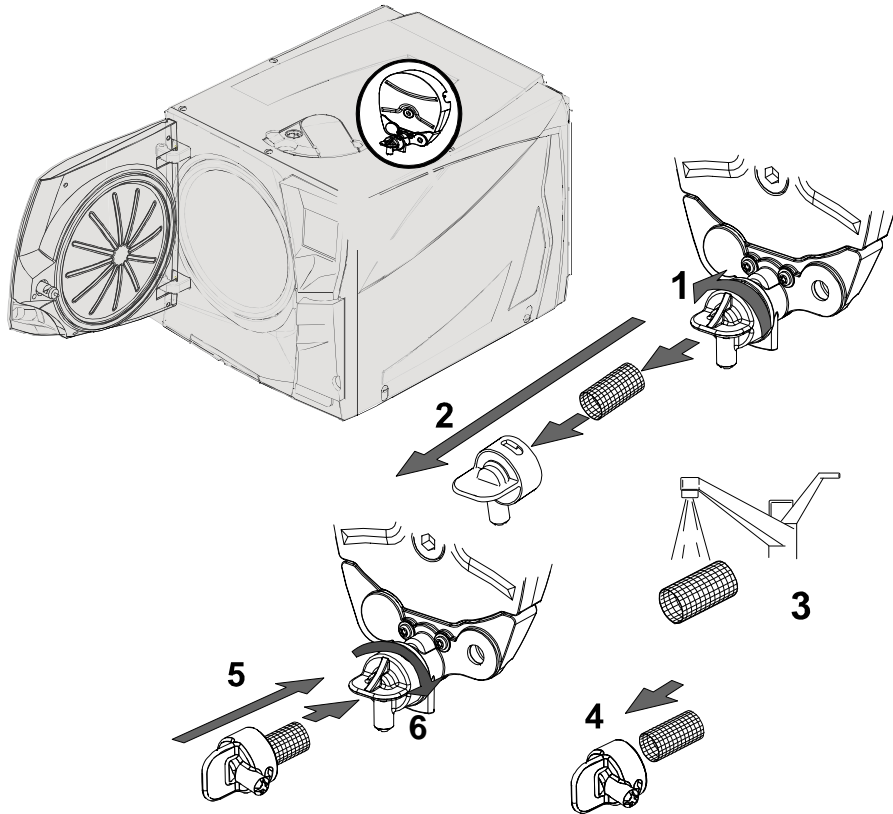

Cleaning the chamber filter

Empty the sterilizer chamber by removing the trays and the rack.

1–2: Remove the filter cap at the back of the chamber (bottom/center) by turning it counter-clockwise.

3: Remove the cartridge filter and rinse it with tap water.

4–5–6: Insert the filter in the cap, attach the filter cap and lock it by turning clockwise.

Cleaning the external surfaces of the sterilizer

Clean all external sterilizer covers with a slightly damp cloth moistened with water.

Never use disinfectants, detergents or abrasive products.

3 month or 400-cycle maintenance

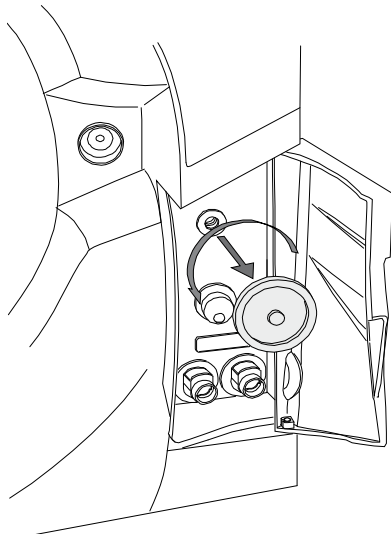

Replacing the bacteriological filter

Open the service door.

Unscrew the bacteriological filter by hand (counter-clockwise).

Screw on the new bacteriological filter (clockwise) and tighten it snug.



Remember to reset the counter after replacement (see following pages).

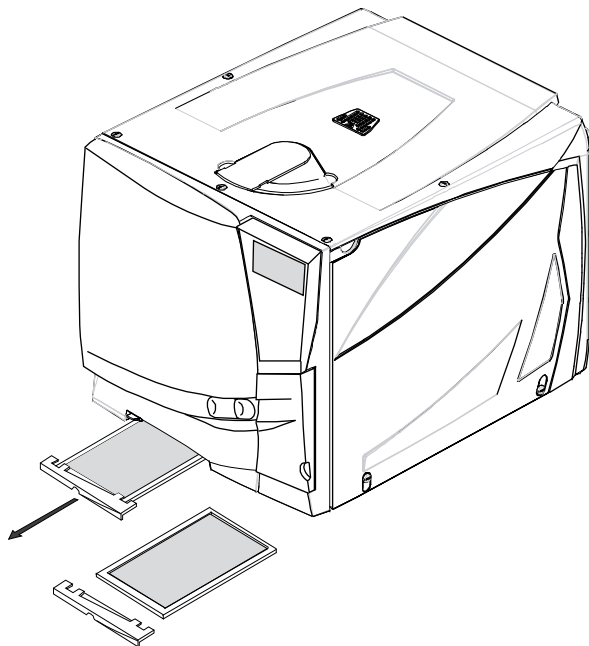

Replacing the dust filter

Pull out the dust filter from underneath the sterilizer.

Detach the used filter from the handle.

Attach the new filter to the handle.

Slide the filter back into its original position.



Remember to reset the counter after replacement (see following pages).

6 month or 800-cycle maintenance

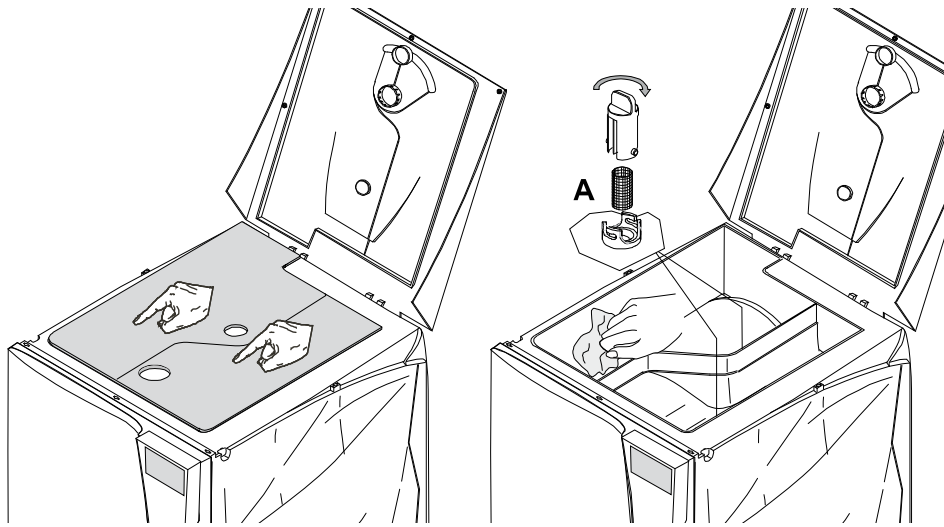
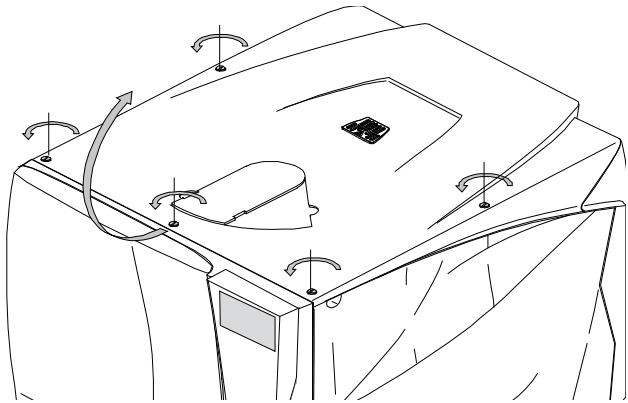

Cleaning the water tanks

Switch OFF the sterilizer and disconnect the mains cable.

Completely drain both tanks.

Leave the drain tube attached to one of the drain quick connectors.

Turn the 5 screws of the tank cover a $\frac{1}{4}$ with the use of a screwdriver (a coin works as well) and lift the cover to gain access to the tanks. Tap with your fingers on the rubber membrane to remove any condensate.

Remove the rubber membrane; clean and dry it.

Clean the internal tank surfaces with a soft sponge and a mild detergent solution, then rinse and dry them. Make sure the drain tube is connected to the tank you are cleaning (left tank – grey colored connector; right tank – blue colored connector) to drain the detergent solution.

Only when both tanks are clean, remove the internal filters (A), clean them with tap water and put them back into their position. Reposition the rubber membrane.

Close the cover and tighten the 5 tank cover $\frac{1}{4}$ turn screws.

Disconnect the drain tube.



Do not use abrasive, strong detergents or disinfectants.

Use a small non-abrasive brush to clean the areas that are difficult to reach.



When cleaning the tanks, be careful not to touch the water level sensors. If misplaced or misaligned from their original position, the operation of the sterilizer could be impaired.

1 year or 800-cycle maintenance

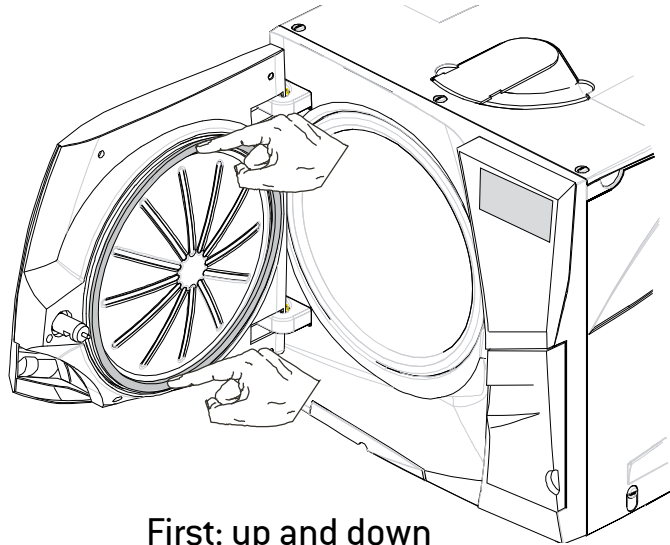

Replacing the door seal

Fully open the chamber door.

Pull out the used door seal by hand (easy if seal and fingers are dry).

Carefully clean the seal seat and the chamber face side with a cotton swab.

Moisten the new seal with water. This will make placement much easier!

Insert the new seal in the sequence as illustrated in the pictures to the left.

Complete the operation by evenly inserting the seal on the entire circumference; ensure the seal does not stick out (no bumps or deformations)!

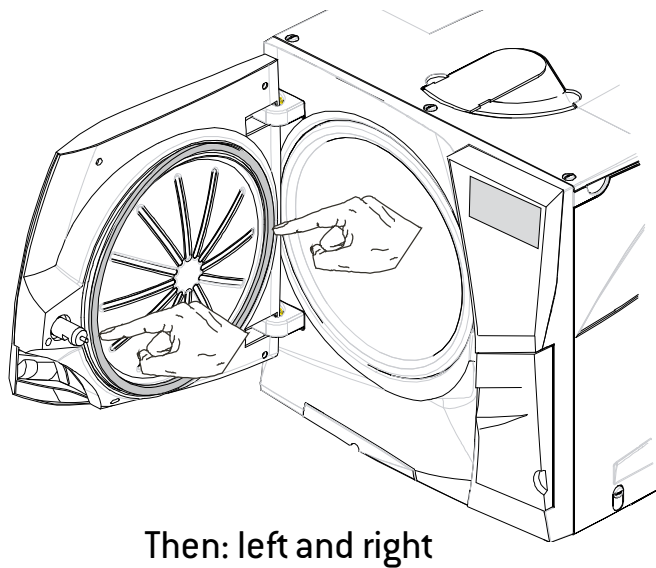

Remember to reset the counter after replacement (see following pages).

4000 cycle/5 years general check and service



Regular service is imperative to ensure continuous and effective operation of the sterilizer.

It is recommended to carry out a general service every 4000 cycles or five years by an authorized service technician.



The service includes replacement of consumables and other important internal components, a check of the entire unit with special care for the safety systems, and cleaning of areas and components that cannot be accessed by the user.

REPLACEMENT PARTS	CLEANING	CHECKS
Solenoid valves Vacuum pump internal parts	Sterilization chamber and external surfaces	Pneumatic connections
	Chamber filter	Electrical connections
	Internal cleaning, with particular care for the condenser fins and the main board	Temperature and pressure calibration
		Door locking system
		Pressure safety valve
	Steam diffuser plate	Safety systems

Resetting the maintenance counters

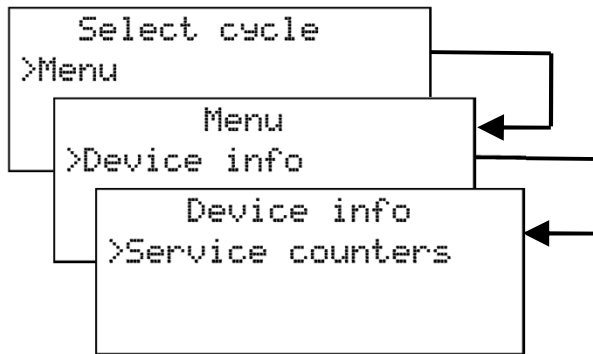

Use the UP, DOWN and OK buttons to browse the menu, choosing the following options in sequence: MENU – DEVICE INFO – SERVICE COUNTERS

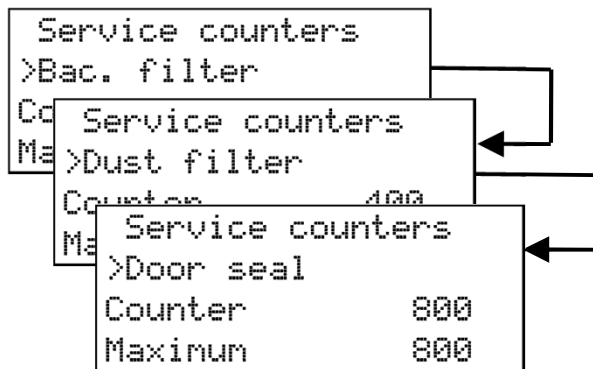

Scroll to the concerned consumable by pressing UP or DOWN. The consumable status (number of cycles executed and maximum lifespan of the consumable) is displayed in the third and fourth line of the display. Press OK to select the concerned consumable.

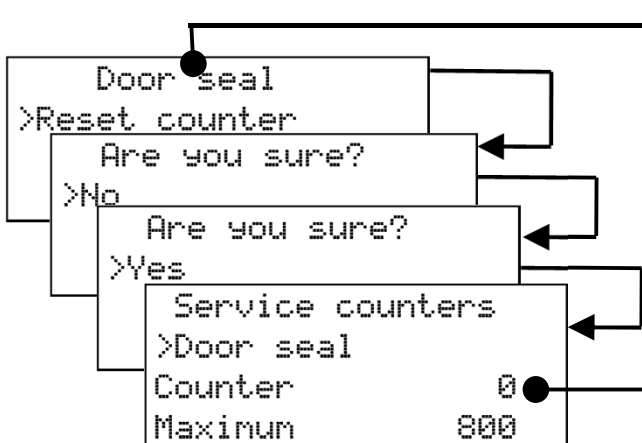

After selecting, the concerned consumable appears in the first line.

The RESET COUNTER option is displayed: confirm it with OK.

A confirmation request appears: scroll the answer to YES by pressing UP or DOWN and then confirm with OK.

After being reset, the consumable counter shows zero.

8. Troubleshooting, alarms and messages

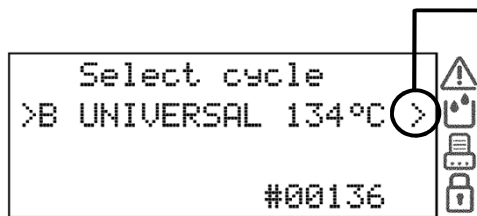

If the cursor appears to the left of one or more icons, there is related information pending. All messages can be viewed by means of the MESSAGES sub-menu.

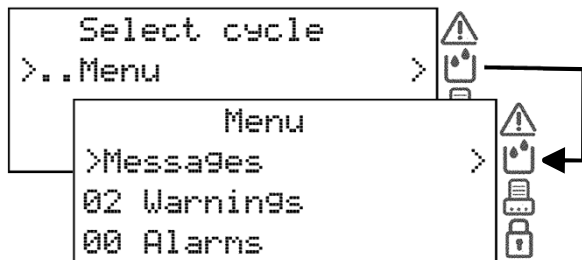

Use the UP, DOWN and OK buttons to browse the menu, choosing the following options in sequence: MENU – MESSAGES.

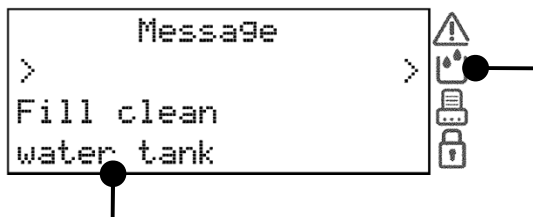

If there is more than one message pending, you can scroll within messages with UP or DOWN.

The icon that is preceded by the cursor is related to the pending message.







The cursor that precedes the icon disappears as soon as the relevant message has been read and the condition that gave rise to the message has been fixed.



The cursors that precede the message icons are not visible while a cycle is in progress.

Messages

ICON	MESSAGE	DESCRIPTION/ACTION REQUIRED
	-	The chamber door is locked; no action required.
	Fill clean water tank	The water level inside the clean water tank is below the minimum. Fill the clean water tank.
	Drain used water tank	The water level inside the used water tank is at maximum level. Drain used water tank.
	Bad water quality Check H2O supply	Check the external sterilizer water supply. You might have to replace filter cartridges – drain clean water tank and follow instructions for use of water filtration system.
	Non conform water Do not use the sterilizer!!	The distilled/demineralized water in the clean water tank is of poor quality. Drain the tank and refill it with water of good quality; refer to APPENDIX 7
	Bad water quality STOP using the sterilizer!!	
	WARNING Chamber is hot!!	Don't touch the chamber or the load with bare hands: high temperature, risk of burns!
	Replace bac. filter	The bacteriological filter needs to be replaced.
	Replace dust filter	The dust filter needs to be replaced.
	Replace door seal	The door seal needs to be replaced.
	4000 cycle service recommended	The 4000 cycle overhaul needs to be performed. Call for service.
	20000 cycles run Call for service	The 20000 cycle overhaul needs to be performed. Call for service.
	WARNING ! Low battery	The CPU board battery needs to be replaced. Call for service.
	PC connection lost Check cables/PC	PC/Logger not detected (disconnected or not powered).
	Printer not ready	Cycle report printer configured but not detected (disconnected or not powered).
	Label printer not ready	Label printer configured but not detected (disconnected or not powered).
	File save error	File saving error (check presence and connection of the USB drive).



NOTE: for any message not listed in this table, call service.

Alarms

Alarm code	DESCRIPTION	ACTION
E010	Power failure during a cycle	Load cannot be considered sterile. Repeat the cycle.
E02x	Internal voltage error	Switch the sterilizer OFF and ON. If the problem persists call service.
E041	Cycle counter lost	Switch the sterilizer OFF and ON. If the problem persists call service. NOTE: Initiating a sterilization cycle is still possible.
E042	Internal clock error	Set date and time - Switch the sterilizer OFF and ON. If the problem persists call service. NOTE: Initiating a sterilization cycle is still possible.
E060	Internal voltage error	Disconnect optional accessories from 24VDC rear plug - switch the sterilizer OFF and ON. If the problem persists call service.
E080	Internal overheating	Check the dust filter and ensure that the sterilizer fan is not blocked.
E090	Internal voltage error	Switch the sterilizer OFF and ON. If the problem persists call service.
E100	Phase timeout	Check water level in the clean water tank. Reset the thermal overload. If the problem persists call service.
E101	Internal probe error	Switch the sterilizer OFF and ON. If the problem persists call service.
E102	Phase timeout	Check water level in the clean water tank. Reset the thermal overload. If the problem persists call service.
E107	Overpressure during the pre-vacuum phase	If the problem persists call service.
E121	Internal probe error	Switch the sterilizer OFF and ON. If the problem persists call service.
E130	Overpressure during the sterilization phase	Clean the chamber and the chamber furniture from residuals of detergents, disinfectants and other chemicals. Replace the clean water if it is suspected to be contaminated with chemicals. Ensure all the load is clean rinsed and free from any chemicals before sterilizing. Repeat the cycle. If the problem persists call service.
E131	Temperature fluctuation during the steril. phase	
E140	Low pressure during the sterilization phase	
E150	Low temperature during the sterilization phase	
E160	Over temperature during the sterilization phase	
E163	Overpressure detected	
E180-E181	Internal probe error.	Switch the sterilizer OFF and ON. If the problem persists call service.



NOTE: for any alarm not listed in this table, call technical service.

Alarms

Alarm code	DESCRIPTION	ACTION
E182	Pressure drop timeout	After the process phase the pressure took too long to drop to the atmospheric pressure. If the problem persists call service.
E184	Overtemperature detected	If the problem persists call service.
E215	Fan blocked or faulty electronic control	Call service.
E230	Internal probe error	Switch the sterilizer OFF and ON. If the problem persists call service.
E231	Overtemperature detected	If the problem persists call service.
E232-E233-E234	Internal probe error	Switch the sterilizer OFF and ON. If the problem persists call service.
E240	Heating element error	Wait for the chamber to cool down. Reset the thermal overload. If the problem persists call service.
E243	Heating element error	Reset the thermal overload. If the problem persists call service.
E310-E320-E33x-E380-E390	Vacuum timeout	Check the door seal; clean or replace if necessary. Clean the chamber face side. Clean the chamber filter. If the problem persists call service.
E510	Door motor: failure after cycle completion	Switch the sterilizer OFF and ON. If the problem persists call service.
E520	Door motor: locking timeout	If the problem persists call service.
E570	Door motor: unable to detect the door position	Switch the sterilizer OFF and ON. If the problem persists call service.
E580	Door motor: door locked check signal lost	If the problem persists call service.
E59x	Door motor error	Switch the sterilizer OFF and ON. If the problem persists call service.
E950	Internal memory error	Switch the sterilizer OFF and ON. If the problem persists call service. NOTE: Initiating a sterilization cycle is still possible.
E95x-E96x	Internal memory error	Switch the sterilizer OFF and ON. If the problem persists call service.
E990	Manual stop	The cycle has been aborted by the user. Re-process the load.



NOTE: for any alarm not listed in this table, call technical service.

Alarm stop

In case certain important sterilization parameters are not met, the sterilizer will generate an alarm code and abort the cycle automatically.

The sterilizer enters into a reset phase; a wait message and an alarm code are displayed on the screen.

```
ALARM.. Please wai
>Info
T: 78.9°C      E331
P: -0.31bar   #00136 >
```

At this stage select and confirm "Info" to view the sterilizer parameters (see Chapter 6 of this manual).

Do not switch off the sterilizer: It will take some time (several minutes) to reset the system and reach safe conditions in the sterilizer chamber before it is possible to open the sterilizer door and remove the load.

```
B UNIVERSAL 134°C
End of alarm E331
Press "back icon" >
```

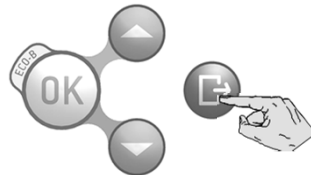

Alarm end

When the reset phase is over, you will be asked to press BACK to get to the "Unlock door" option.

```
B UNIVERSAL 134°C
>Unlock door
End of alarm E331
Load not sterile >
Ster.cond.achieved
drying interrupted
```

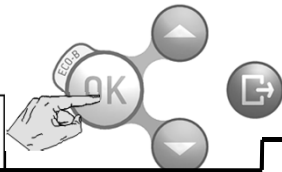

Confirm (OK) to unlock the door.

While the door is unlocking, a waiting message is displayed.

The message "LOAD NOT STERILE" means that the load is not sterile. Do not use items on patients!

The message "DRYING INTERRUPTED" means that the load might be wet. Wet items are for immediate use only!

```
B UNIVERSAL 134°C
Open door!
```

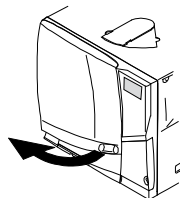

Open the chamber door and remove the load.



Water could be present in the chamber when opening the door: prevent spilling (e.g., place a towel under the chamber door).

Resetting the thermal overload

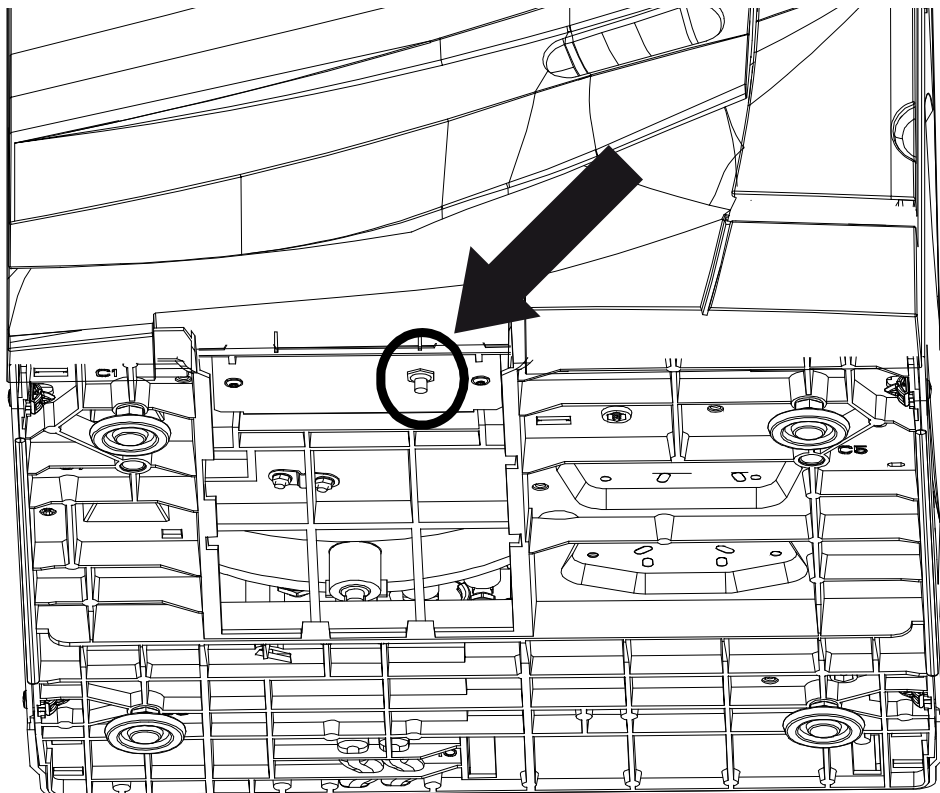
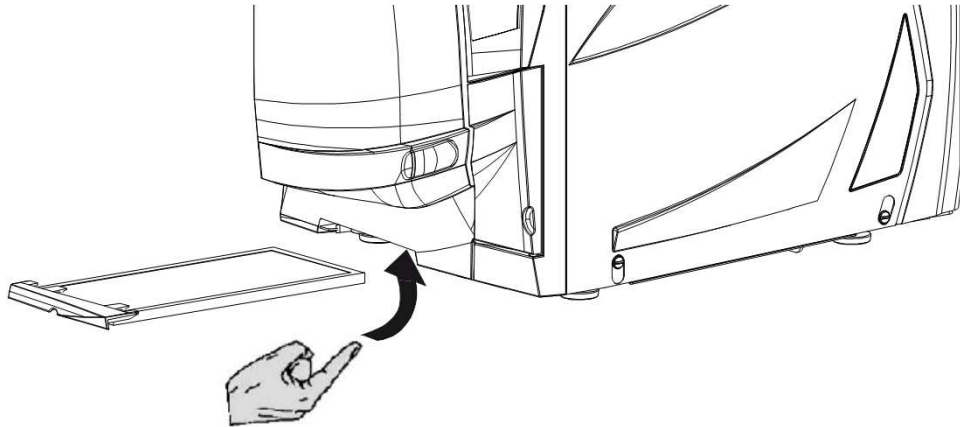

A safety thermostat is fitted on the sterilizer to prevent overheating of the electric heater.

If the safety thermostat opens because of too high temperatures, the alarm E240 or a timeout alarm is generated.

If this happens, proceed as follows:

- Switch the sterilizer OFF and remove the mains cable.
- Wait for the sterilizer to cool down.
- Remove the dust filter.
- Slide your hand underneath the sterilizer where the dust filter was located and push on the reset button of the thermostat switch (see pictures to the left).
- A click sound will indicate that the thermostat switch has been reset.
- Insert the dust filter back into its original position.
- Connect the mains cable and switch the sterilizer ON.
- Wait for the sterilizer to finish the alarm reset phase and follow the instructions on the display.

If the thermostat opens repeatedly, call technical service.

Troubleshooting

PROBLEM	POSSIBLE CAUSE	SOLUTIONS
The sterilizer remains switched OFF.	The main switch or network circuit breaker is OFF	Activate the main switch or network circuit breaker (ON).
	No voltage at the socket	Check the electric circuit.
	The mains cable is not properly connected	Attach the cord set properly.
Water is leaking at the front of the sterilizer	Leaks through the chamber door seal	Clean or replace the door seal. Clean the chamber face side.
	Internal leak.	Call technical service.
The cycle commences but there is no pressure/temperature rise	The thermal overload switch is open	Reset the thermal overload switch (see “Resetting the thermal overload” in this manual).
	Electric – electronic fault	Call technical service.
At the end of the cycle, there is residual water in the chamber	Sterilizer not properly levelled	Properly level the surface the sterilizer is placed on.
	Overloaded chamber	Comply with the maximum load weight limits for each type of load. Always use the chamber rack for trays and cassettes.
	Chamber filter clogged	Remove and clean the chamber filter.
	Load incorrectly placed	Follow the recommendations as listed in APPENDIX 2.
Corrosion or spots on instruments	Tap water on instruments when placed in the sterilizer	Ensure that instruments are dry before they are placed in the sterilizer.
	Use of water of poor quality or water containing chemical substances	Drain both water tanks. Use water of good quality (see APPENDIX 7).
	Organic or chemical residues on the instruments	Clean, rinse and dry instruments before placing them in the sterilizer (see APPENDIX 2).
	Contact between instruments of different materials	Ensure that instruments of different materials do not touch (aluminum, carbon or stainless steel, etc.); place them on different trays or cassettes or pouch them (refer to APPENDIX 2).
	Scale deposits on the chamber	Clean the chamber and use water of good quality (refer to APPENDIX 7).
Instruments are turning brown or black.	Incorrect temperature selected	Select a sterilization cycle featuring a lower sterilization temperature. Follow the instructions of the instrument manufacturer.
The cycle report printer does not work	Printer not properly connected or not powered	Check the data and the power connection to the printer.
	Serial port not configured	If the printer is connected directly: configure the serial port to “Printer” (see Table 2). If connected via PC/Logger: configure the serial port to “PC/Logger” (see Table 2).
	The cycle is in progress and the automatic report printing is enabled	You are trying to print a stored cycle but the printer is busy to print the data of the cycle in progress: the requested printout will be queued. NOTE: The max. queue is 5 cycles. Longer queues will be ignored.
No cycles are stored in the cycle history menu	Power board replaced by service	These service steps cause loss of memory.
	Serial number re-entered by service	

Troubleshooting

PROBLEM	POSSIBLE CAUSE	SOLUTIONS
When starting a cycle, the chamber door locks but re-opens immediately. The “Open the door” message appears.	Door seal not properly placed; seal sticking out	Ensure that the door seal is evenly inserted on the entire circumference.
	OK button was pressed twice to launch the cycle	Try again by pressing OK only once.
	Door jammed by external objects or by the load itself	Remove any objects interfering with the chamber door. Check the door does not force against the load or the chamber furniture.
When the sterilizer is connected to an automated water supply system: There is no clean water in the tank, but the automatic water filling does not start.	Water fill system (optional) not installed	Install a water fill system.
	Water fill system (optional) not connected	Connect the water fill system to the sterilizer (see Appendix 7 for water quality requirements).
	Water fill system (optional) not configured	Enable the water fill system in the “Configuration” sub-menu (see Chapter 5, Table 2).
	When the water fill system attempted to fill the tank, water was temporarily unavailable	Since water tank filling is attempted only once in-between cycle execution, this event inhibits water feeding. Switch the sterilizer OFF and then ON again. Check the external water supply system. Check for water leaks from the sterilizer.
The sterilizer enters into “Sleep mode” immediately after opening the chamber door.	The chamber door has not been opened after the previous cycle had finished and the “Sleep mode delay” has expired	Press any button on the control panel to exit from “Sleep mode”.
At the end of the cycle the display reads “Open the door” but opening the door is impossible.	The chamber is in vacuum due to an internal malfunction	Switch the sterilizer OFF: this will release any internal pressures allowing the chamber door to be opened. Call technical service if the problem persists.
	The bacteriological filter is blocked	Remove the bacteriological filter to get the pressure released. Replace the filter. Note that bacteriological filters need to be replaced every 400 cycles.
The sterilization (PROCESS) phase of a sterilization cycle was longer than expected.	The chamber temperature dropped below the minimum threshold and the software performed a successful recovery	Wait for cycle completion. If the problem occurs frequently, call technical service.



Before sending the sterilizer for technical service, remove the mains cable, empty both water tanks and use the original or appropriate packaging.

9. Recycling and disposal



LINA MB sterilizers are mainly built from fiber-reinforced polymers, metals and electronic components.

In case of disposal:

- separate the various components according to the materials they are made of;
- drop the sterilizer with a company that specializes on the recycling of related products;
- do not abandon the sterilizer in unsecured places;
- always refer to current/applicable laws and rules in the country of use.

The same instructions apply to disposal of all used consumable parts.

APPENDIX 1. Technical data

TECHNICAL DATA	
Electrical supply:	200 - 240 VAC – 50/60 Hz, single - phase
Nominal voltage:	200 - 240 VAC
Max. power:	1750 W
Max. current:	8.75 A
Sterilizer:	
Working temperature:	from +5°C to +40°C
Working relative humidity:	Max. RH 80% up to 31°C, linearly decreasing to 50% at 40°C
Storage temperature /rel. humidity:	-20°C to +60°C/0-90% (with empty tanks)
Max altitude:	4000m asl
Min. atmospheric pressure:	0.6 barA
Overall dimensions:	W: 450 mm/H: 435 mm/D: 599 mm
Min. space required:	W: 470 mm/H: 485 mm/D: 650 mm
Size of the door movement:	W: 360 mm/H: 410 mm/D: 360 mm
Weight empty:	38 kg (LINA MB17), 40.5 kg (LINA MB22)
Max. weight (fully loaded):	50 kg (LINA MB17), 53 kg (LINA MB22)
Max. weight per support area:	785 kN/mm ²
Max. heat output:	3000 KJoule/hour
Max noise level:	63 dB
Pressure safety valve:	3 bar
Safety thermostat	330°C
Sterilizer chamber:	
Total volume:	17 l/Ø 250 mm x D 362 mm (LINA MB17) 22 l/Ø 250 mm x D 440 mm (LINA MB22)
Usable space (for all cycles)	12 l/W195 mm x H 195 mm x D 297 mm (LINA MB17)) 15.5 l/W 195 mm x H 195 mm x D 390 mm (LINA MB22)
Bacteriological filter:	0.3 µm
Distilled or demineralized water:	
Water quality:	Fulfilling EN 13060 Ann. C (conductivity < 15µS/cm)
Average water consumption:	0.7 litres/cycle
Tank volume:	2 x 3.6 liters
External water supply:	To be compliant with IEC61770
Pressure:	min. 2 bar – max. 8.6 bar
Flow:	min. 0.25 – max 0.5 l/min
Communication with other devices:	1 serial port (optional: USB + 2 serial ports)
Other	Fully micro-processor controlled, process evaluation system according to EN13060. Programmable sleep-mode.

CONFORMITIES	
STERILIZER featuring type B sterilization cycles conform with the following standards:	
93/42/CEE	Medical Device Directive (MDD)
97/23/CEE	Pressure Equipment Directive (PED)
2002/96/CEE	Waste Electrical and Electronic Equipment (WEEE)
EN 13060	Small steam sterilizer
IEC 61010-1	Safety requirements for electrical equipment for measurement, control and laboratory use, general requirements
IEC 61010-2-040	Safety requirements for electrical equipment for measurement, control and laboratory use; particular requirements for autoclaves using steam for the treatment of medical materials and for laboratory processes.
EN 61326	Electrical equipment for measurement, control and laboratory use: EMC requirements.

PRODUCT LABELS																																																																
<table border="1"> <tr> <td>Model / Modèle</td> <td>Lina MB22</td> <td>Max. W.P. / P. Max.</td> <td>3 bar / 43.5 psi</td> </tr> <tr> <td>Code</td> <td>P0001090</td> <td>Max. W.T. / T. Max.</td> <td>144 °C / 291.2 °F</td> </tr> <tr> <td>SN</td> <td>XXXXXX</td> <td>2011</td> <td></td> </tr> <tr> <td>Type B</td> <td>22 L / 23 qt</td> <td></td> <td></td> </tr> <tr> <td>200+240 Vac</td> <td>50 / 60 Hz</td> <td></td> <td></td> </tr> <tr> <td>8.75 A</td> <td>1.75 kW</td> <td></td> <td></td> </tr> </table> <p style="text-align: center;">Data plate</p> <table border="1"> <tr> <td colspan="2">Sterilization chamber/Chambre de stérilisation</td> </tr> <tr> <td>Product code/Code produit</td> <td>S52151XX</td> </tr> <tr> <td>Year/Année</td> <td>20XX</td> </tr> <tr> <td>SN</td> <td>XXXXXX</td> </tr> <tr> <td>Max. Pressure/Max. Pression</td> <td>3 bar</td> </tr> <tr> <td>Min. Pressure/Min. Pression</td> <td>- 0.99 bar</td> </tr> <tr> <td>Max. temperature/Max. Température</td> <td>144 °C</td> </tr> <tr> <td>Test pressure/Pression de test</td> <td>4.3 (3x1.43) bar</td> </tr> <tr> <td>Volume/Volume</td> <td>XX L / XX qt</td> </tr> </table> <p style="text-align: center;">Sterilization chamber label</p>	Model / Modèle	Lina MB22	Max. W.P. / P. Max.	3 bar / 43.5 psi	Code	P0001090	Max. W.T. / T. Max.	144 °C / 291.2 °F	SN	XXXXXX	2011		Type B	22 L / 23 qt			200+240 Vac	50 / 60 Hz			8.75 A	1.75 kW			Sterilization chamber/Chambre de stérilisation		Product code/Code produit	S52151XX	Year/Année	20XX	SN	XXXXXX	Max. Pressure/Max. Pression	3 bar	Min. Pressure/Min. Pression	- 0.99 bar	Max. temperature/Max. Température	144 °C	Test pressure/Pression de test	4.3 (3x1.43) bar	Volume/Volume	XX L / XX qt	<table border="1"> <tr> <td></td> <td></td> <td></td> </tr> <tr> <td>97/23/CEE</td> <td>93/42/CEE</td> <td></td> </tr> <tr> <td colspan="3" style="text-align: center;"></td> </tr> <tr> <td colspan="3" style="text-align: center;">Produced by / Produit par</td> </tr> <tr> <td colspan="3" style="text-align: center;"></td> </tr> <tr> <td colspan="3"> W&H Sterilization s.r.l. Italy, I - 24060 Brusaporto Bergamo (BG), Via Bolgara, 2 t. +39 035 66 63 000 f. +39 035 50 96 988 wh.com </td> </tr> <tr> <td colspan="3" style="text-align: center;">Made in Europe Produit en Europe</td> </tr> </table> <p style="text-align: center;">Manufacturer label</p>				97/23/CEE	93/42/CEE					Produced by / Produit par						W&H Sterilization s.r.l. Italy, I - 24060 Brusaporto Bergamo (BG), Via Bolgara, 2 t. +39 035 66 63 000 f. +39 035 50 96 988 wh.com			Made in Europe Produit en Europe		
Model / Modèle	Lina MB22	Max. W.P. / P. Max.	3 bar / 43.5 psi																																																													
Code	P0001090	Max. W.T. / T. Max.	144 °C / 291.2 °F																																																													
SN	XXXXXX	2011																																																														
Type B	22 L / 23 qt																																																															
200+240 Vac	50 / 60 Hz																																																															
8.75 A	1.75 kW																																																															
Sterilization chamber/Chambre de stérilisation																																																																
Product code/Code produit	S52151XX																																																															
Year/Année	20XX																																																															
SN	XXXXXX																																																															
Max. Pressure/Max. Pression	3 bar																																																															
Min. Pressure/Min. Pression	- 0.99 bar																																																															
Max. temperature/Max. Température	144 °C																																																															
Test pressure/Pression de test	4.3 (3x1.43) bar																																																															
Volume/Volume	XX L / XX qt																																																															
97/23/CEE	93/42/CEE																																																															
Produced by / Produit par																																																																
W&H Sterilization s.r.l. Italy, I - 24060 Brusaporto Bergamo (BG), Via Bolgara, 2 t. +39 035 66 63 000 f. +39 035 50 96 988 wh.com																																																																
Made in Europe Produit en Europe																																																																

APPENDIX 2. Maintenance of dental handpieces

External disinfection

This procedure reduces the risk of infection during cleaning and maintenance of the instrument.

Wear protective gloves during disinfection.

Refer to the instructions of the instrument manufacturer.

Avoid using abrasive disinfectants (pH-value 2.5 – 9; no chlorine based disinfectants).

We recommend the use of disinfectant wipes rather than spray disinfection.

Do not immerse instruments in disinfectants.

Residual disinfectants on instruments can cause extensive damage to your instrumentation during sterilization (oxidation, alteration of technical characteristics of seals, rubbers, fiber optics, etc.).

External cleaning

This procedure involves the removal of residues (blood, dentine, etc.) that adhere to critical areas such as spray outlets, light ports, knurling etc.

Wear protective gloves during cleaning.

Refer to the instructions of the instrument manufacturer.

Use a soft, damp brush and take care not to scratch the surface of the light ports.

Lubrication

Once the instrument has been disinfected, cleaned and dried (free from residues), it must be lubricated **prior to** sterilization.

Follow manufacturer's instructions for proper lubrication.

Packaging

In order to preserve sterility, rotating instruments should be wrapped/bagged prior to sterilization. Follow the manufacturer's packing instructions when using sterilization packaging (also see "Sterilization load preparation" in APPENDIX 2 of this manual).

APPENDIX 3. Sterilization load preparation

Cleaning the instruments

Clean all instruments thoroughly prior to sterilization.

If possible, clean instruments immediately after use; always follow the instrument manufacturer's instructions.

Remove all traces of disinfectants and detergents.

Rinse and dry carefully all instruments.

Lubricate dental handpieces after cleaning and prior to sterilization in accordance with the manufacturer's instructions.



The instruments must be carefully rinsed and dried prior to sterilization.

Any residual of chemicals (like cleaning and disinfection products), could affect the purity of the steam and consequently the whole sterilization process, and could seriously damage the sterilizer.

The manufacturer's warranty is void in case of damage from chemicals coming from the load or added to it.

Preparing the trays

Do not overload the chamber; adhere to the maximum load weight limits (see cycle program table; the available sterilization cycles).

Always use the chamber rack to allow adequate steam circulation.

Place pouched items on trays with the paper side facing up.

Do not overload trays; spread single items on multiple trays.

Place cassettes in the vertical position (if possible) to enhance drying.

Place empty containers or non-perforated trays upside down to prevent accumulation of water.

Items made from different materials (stainless steel, carbon steel, aluminum, etc.) must be placed on separate trays or wrapped/pouched.

If the instruments are manufactured from carbon steel, paper should be placed between them and the trays to avoid rusty spots.

Sterilize hinged instruments (e.g., forceps, extraction pliers, etc.) in the open position.

Wrap items with porous wrapping materials to facilitate steam penetration and drying (e.g. sterilization bags for autoclaves).

Loading the chamber

Tubes

Rinse, drain and dry tubes after washing.

Place tubes on a tray allowing the ends to remain open. Do not bend tubes.

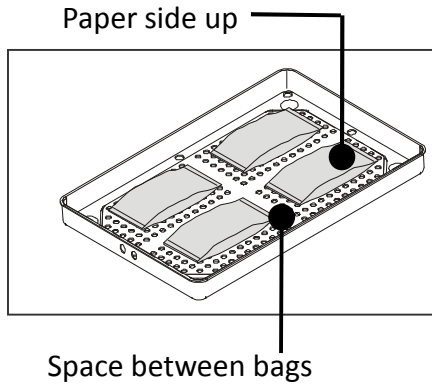

Wrapped/bagged items

Place the bags on trays allowing adequate space in-between bags.

Ensure that packs do not touch the sterilizer chamber walls.

Place sterilization bags with the paper side facing up.



Never place the load or the trays directly into the chamber without the chamber rack as this could affect the steam and temperature distribution. The load must always be supported by the chamber rack.

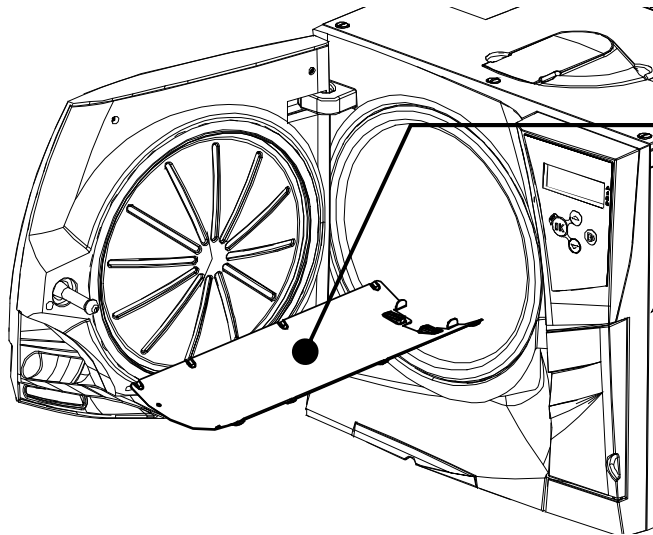

Before initiating a sterilization cycle, always check that the steam diffuser plate is properly positioned.



An improper positioning of the steam diffuser plate could result in bad steam quality and could impair the sterilization process, with risk of non sterile load and cross infection.

Sterility at the end of the cycle is not guaranteed if the steam diffuser plate was not correctly placed.



Before touching, ensure the sterilization chamber is cold: risk of burns!

APPENDIX 4. Bowie and Dick test

Description

The Bowie & Dick (B&D) test device is used to validate the sterilizer performance for textile load sterilization. It is made of several sheets of paper wrapped in a small packet in the middle of which there is a chemical heat-sensitive indicator sheet.

How to carry out the test

The test must be performed in an empty chamber (EN13060) without load but with the standard chamber accessories (chamber rack and trays) mounted.

Place the Bowie & Dick test pack in the center of a tray in the lowest rack position.

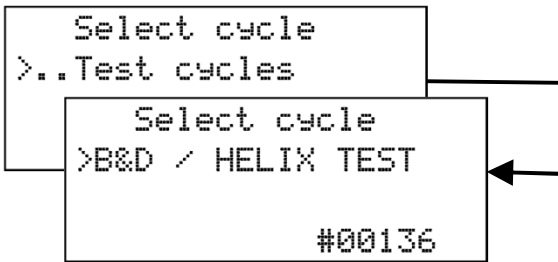

Use the UP, DOWN and OK buttons to browse the menu, choosing the following options in sequence: TEST CYCLES – B&D/HELIX.

Initiate the cycle (see “Running a sterilization cycle”).

Once the cycle is finished, remove the test pack from the chamber.

Remove the indicator sheet from the center of the test pack and check the change in colour:

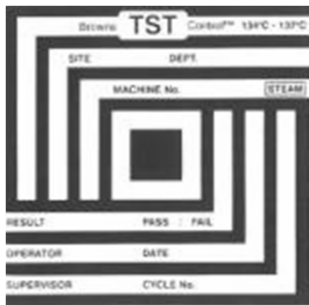

TEST PASSED

The entire surface of the indicator sheet has changed colour.

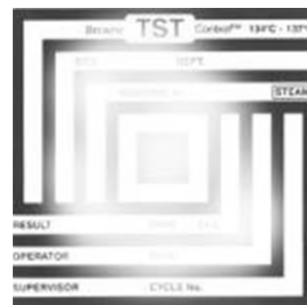

TEST FAILED

Certain areas of the indicator sheet have not changed colour, e.g., the central part has not turned dark due to an air pocket in the center of the test pack.



The test pack will be very hot at the end of the cycle! It is normal that the test pack is wet.

Test failure indicates that there was an air pocket present during the cycle due to sterilizer malfunction.

If the test fails repeatedly call technical service.

Follow local/national guidelines on the frequency of testing.



APPENDIX 5. Helix test

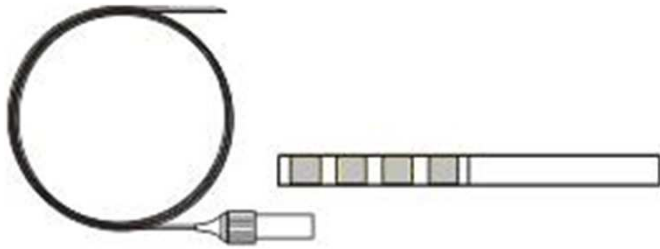

Description

The Helix test device is used to validate the sterilizer performance for hollow items. It consists of a 1,500 mm long tube that is open on one side and closed with a capsule on the other side. A chemical indicator strip is placed inside of the capsule.

How to carry out the test

The test must be performed in an empty chamber (EN13060) without load but with the standard chamber accessories (chamber rack and trays) mounted.

Place an indicator strip inside the capsule according to the instructions of the test manufacturer. Close the capsule.

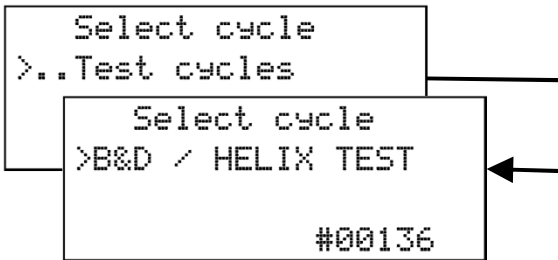
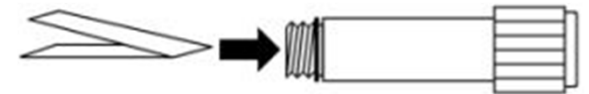

Use the UP, DOWN and OK buttons to browse the menu, choosing the following options in sequence: TEST CYCLES – B&D/HELIX.

Initiate the cycle (see “Running a sterilization cycle”).

Once the cycle is finished, remove the test device from the chamber.

Remove the indicator strip from the capsule and check the change in colour:

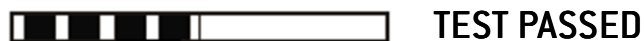

The indicator strip has turned dark.

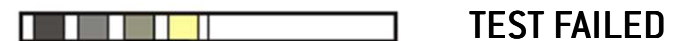

Part of the chemical indicator strip has not turned dark; e.g. due to residual air inside the capsule.



Test failure indicates that there was an air pocket present during the cycle due to sterilizer malfunction.

If the test fails repeatedly call technical service.

Follow local/national guidelines on the frequency of testing.

APPENDIX 6. Vacuum test

Description

The vacuum test is designed to validate the sterilizer performance in terms of:

- Efficiency of the vacuum pump;
- Tightness of the pneumatic circuit.

It consists of a vacuum phase, followed by a stabilization period of 5 minutes and a testing period of 10 minutes.

During the 10-minute testing period the internal pressure is monitored. The pressure rise must be less than 0.013 bar.

How to carry out the test

The test must be performed when the **sterilizer chamber is completely dry and cold** as otherwise the test could produce a “false negative” outcome.

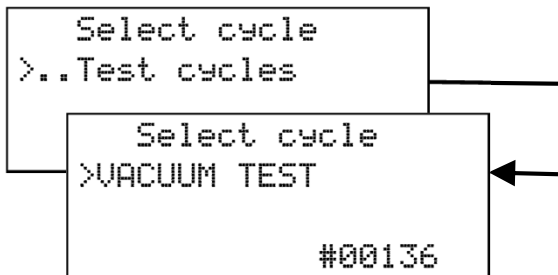

Use the UP, DOWN and OK buttons to browse the menu, choosing the following options in sequence: TEST CYCLES – VACUUM TEST.

Initiate the cycle (see “Running a sterilization cycle”).



Once the cycle is finished, you will be able to open the chamber door.
A display message will inform if the test passed or failed.



If the test failed, check, clean or replace the door gasket, clean the chamber face side and the chamber filter; repeat the test.
If the test fails repeatedly call technical service.
Follow local/national guidelines on the frequency of testing.

APPENDIX 7. Water quality

LINA MB sterilizers use distilled or demineralized water to generate steam for the sterilization process.

The table below lists the maximum content of minerals and the specifications for the water used for steam sterilization (see EN13060 APPENDIX C).

FEED WATER SPECIFICATIONS	
Contaminants/minerals/qualities	Value/Specification
Evaporate residue	< 10 mg/l
Silicon oxide, SiO ₂	< 1 mg/l
Iron	< 0,2 mg/l
Cadmium	< 0,005 mg/l
Lead	< 0,05 mg/l
Heavy metals (excl. iron, cadmium, lead)	< 0,1 mg/l
Chloride	< 2 mg/l
Phosphate	< 0,5 mg/l
Conductivity [at 20°C]	< 15 µs/cm
pH value	5 - 7
Appearance	colorless, clean, free from sediment
Hardness	< 0,02 mmol/l
Chemical additives	No chemicals or additives must be added to the water used for the steam sterilization process , even if they are specifically claimed for use in steam generators, or for steam production, or as additives for sterilization, disinfection, cleaning or corrosion protection.



The use of water with a conductivity greater than 15µS/cm may affect the sterilization process and damage the sterilizer.

The use of water with a conductivity greater than 50µS/cm, or not complying with the specifications in the table above, may strongly affect the sterilization process and seriously damage the sterilizer.

The manufacturer's warranty is void if the sterilizer was used with water containing contaminant or chemical levels exceeding those listed in the table above.

APPENDIX 8. Example of cycle data report

Sterilizer brand	→	W&H Sterilization			
Sterilizer model and serial number	→	LINA MB 101000			106415

Surgery – practice – doctor name	→	Dr. Smith			
Cycle name	→	Cycle:		B UNIVERSAL 134	
Cycle counter	→	Number:			1898
Programmed sterilization temperature	→	Sterilizat. temp			134,0°C
Programmed sterilization time	→	Sterilizat. time			04.00
Programmed drying time	→	Drying time			15.00
Cycle start date and time	→	Date/time:		02/05/2011 10.12	
Headers for the table below	→	Phase	Time	part.	T °C P Bar

Cycle start	→	Start	0.00	0.00	20,4 0,00
Pre-heating phase	→	HEA	08.17	08.17	90,9 0,02
Pressure and vacuum pulses	→	PV1	10.14	01.57	53,5 -0,86
	→	PP1	13.00	02.46	102,7 0,15
	→	PV2	15.45	02.45	57,7 -0,83
	→	FP2	18.58	03.13	102,7 0,15
	→	PV3	21.50	02.52	62,2 -0,83
Phase of pressure rise to sterilization conditions	→	PPH	30.48	08.58	134,5 2,11

Sterilization phase (process) start	→	PRs	30.48	00.00	134,5 2,11
Min. and max. temperatures during the sterilization phase (process)	→	Min.	00.00		134,5 ----
	→	Max.	02.24		135,4 ----
Min. and max. pressures during the sterilization phase (process)	→	Min.	00.00		---- 2,11
	→	Max.	02.21		---- 2,16
Process end conditions	→	PRe	34.48	04.00	135,3 2,15

Drying phase start	→	DRVs	34.48	00.00	135,3 2,17
Drying phase end	→	DRVe	49.48	15.00	70,9 -0,86

Chamber venting phase	→	VEN	50.48	01.00	73,8 -0,01
Pressure leveling phase	→	LEV	50.49	00.01	73,9 -0,01
Cycle end conditions	→	END	50.49	00.00	73,9 -0,01
		Var_1			97
Cycle enddate and time	→	Date/time:		02/05/2011 11.03	
Cycle outcome	→			Cycle completed	

Tracking code for traceability management	→	Trk:			CC18A8800084

APPENDIX 9. Accessories and spare parts

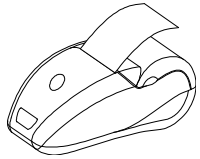

Printer model S'Print
part n. 19721108

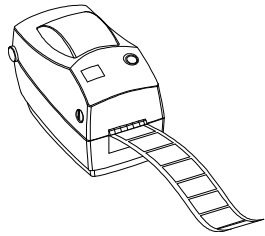

Label printer LisaSafe
part n. 19721101 (with bar code reader)
part n. 19721102 (without bar code reader)



Multiport (PC/logger)
part n. 19721118

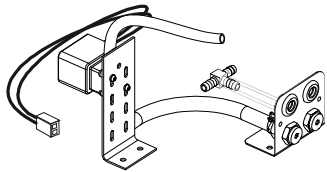

Automatic water feed and drain kit
part n. X051110x

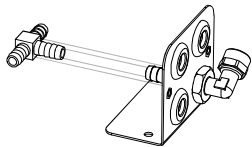

Permanent drain kit
part n. X051052x

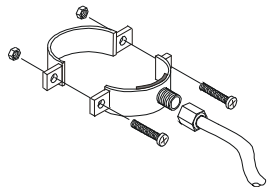

Drain tube kit with fittings
part n. A812110X

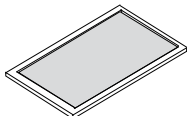

Dust filter
part n. F364502x



Aluminium tray
LINA MB17: part n. F523204x
LINA MB22: part n. F523205x



Tray holder
part n. F523001x



Funnel
part n. F540903x



Bacteriological filter
part n. W322400x



Door seal
part n. F460504x



Wall spacer
part n. F190107x



Safety bracket kit
part n. X051019x



Drain tube
part n. S230900x



Mains cable
part n. U38010xx

Accessories

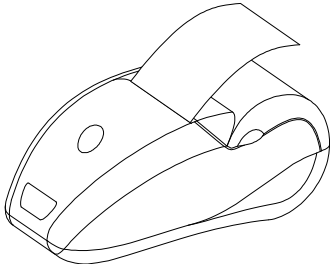

Cycle report printer (S'Print) - part n. 19721108

S'Print is a compact, reliable and easy-to-use printer that can be connected directly to the serial port located in the rear of the sterilizer, or via the Multiport (optional PC/logger, see next page).

S'Print can be easily managed from the sterilizer control panel (See Chapter 5 - Programming) in order to:

- Print cycle data reports (see Appendix 8 “Example of a cycle data report”) at the end of each cycle either in automatic or manual print mode;
- Print a report of any cycle stored in the sterilizer memory.

Printouts are very durable and can be stored in the file records for years.

Label printer (LisaSafe) - part n. 19721101 (with bar code reader), 19721102 (without bar code reader)

LisaSafe is a fast label printer that can be connected directly to the serial port located in rear of the sterilizer, or via the Multiport (optional PC/logger, see next page).

LisaSafe prints self-adhesive permanent paper labels to be attached to pouches, showing:

- either the main information of the cycle and the sterile load (cycle number and type, date, time, expiry date);
- or the sterilization lot number.

LisaSafe is conceived to be the heart of the traceability system in the dental practice, permitting a safe and easy management of the stock of sterilized tools and instruments.

LisaSafe is also compatible with the W&H sterilizers series 300, 500 and 500 Fully Automatic.

All the label printer functions can be easily controlled from the sterilizer control panel (See Chapter 5 - Programming) in order to:

- Print a selected number of labels at the end of the cycle, either in automatic or manual print mode;
- Print extra labels of the most recent cycle;
- Print labels of any cycle stored in the sterilizer memory.

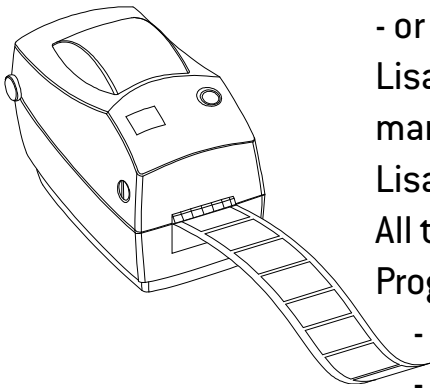

Accessories

Multiport (PC/logger) - part n. 19721118

Multiport is an intelligent hub device that connects to the sterilizer rear serial port and allows managing a variety of optional endorsed devices (see connection schemes on the following pages).

Multiport supports/features:

- The cycle report printer S'Print (see description on the previous page);
- The label printer LisaSafe (see description on the previous page);
- A port for sending cycle data to a PC/network for data storage;
- A USB port to attach a USB storage memory device (included in the product package) for data storage without using a PC.

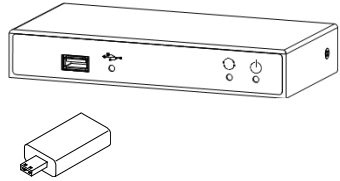

Water feed system - part n. X051110X

Mount this kit in the sterilizer if you want to connect a water filtration system to automatically fill the clean water tank with demineralized water and drain the used water tank continuously.

The kit needs to be mounted by an authorized service technician, or by the factory upon specific order request.

Water quality provided by the filtration system has to comply with Appendix 7. The water supply pressure must be between 2 and 8,6 bar.

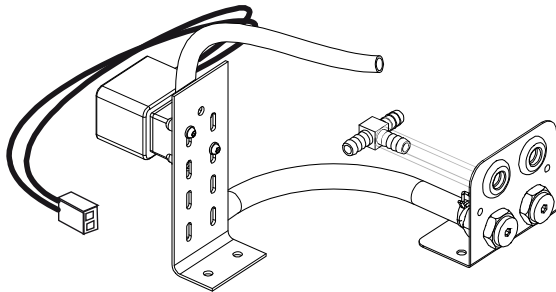

Permanent drain kit - part n. X051052x

This kit is mounted to continuously drain the used water tank, thus manual tank draining is no longer necessary.

The kit needs to be mounted by an authorized service technician, or by the factory upon specific order request.

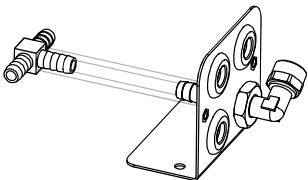

Drain tube kit with fittings - part n. A812110X

Use this kit to connect the sterilizer permanent drain to a drain pipe.

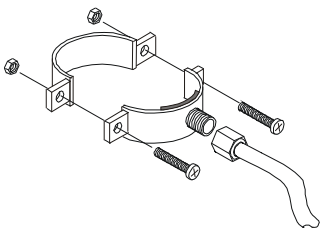

Accessory connection scheme (data communication)

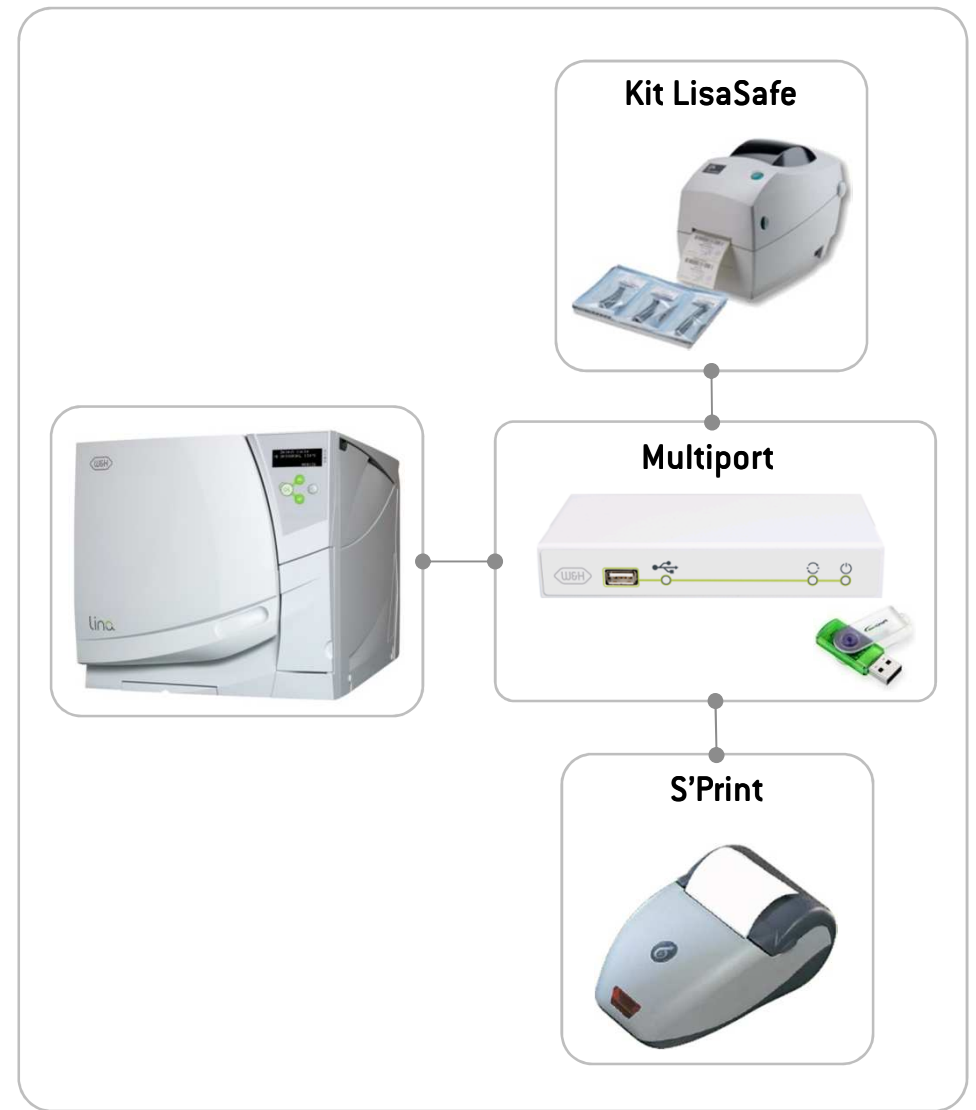
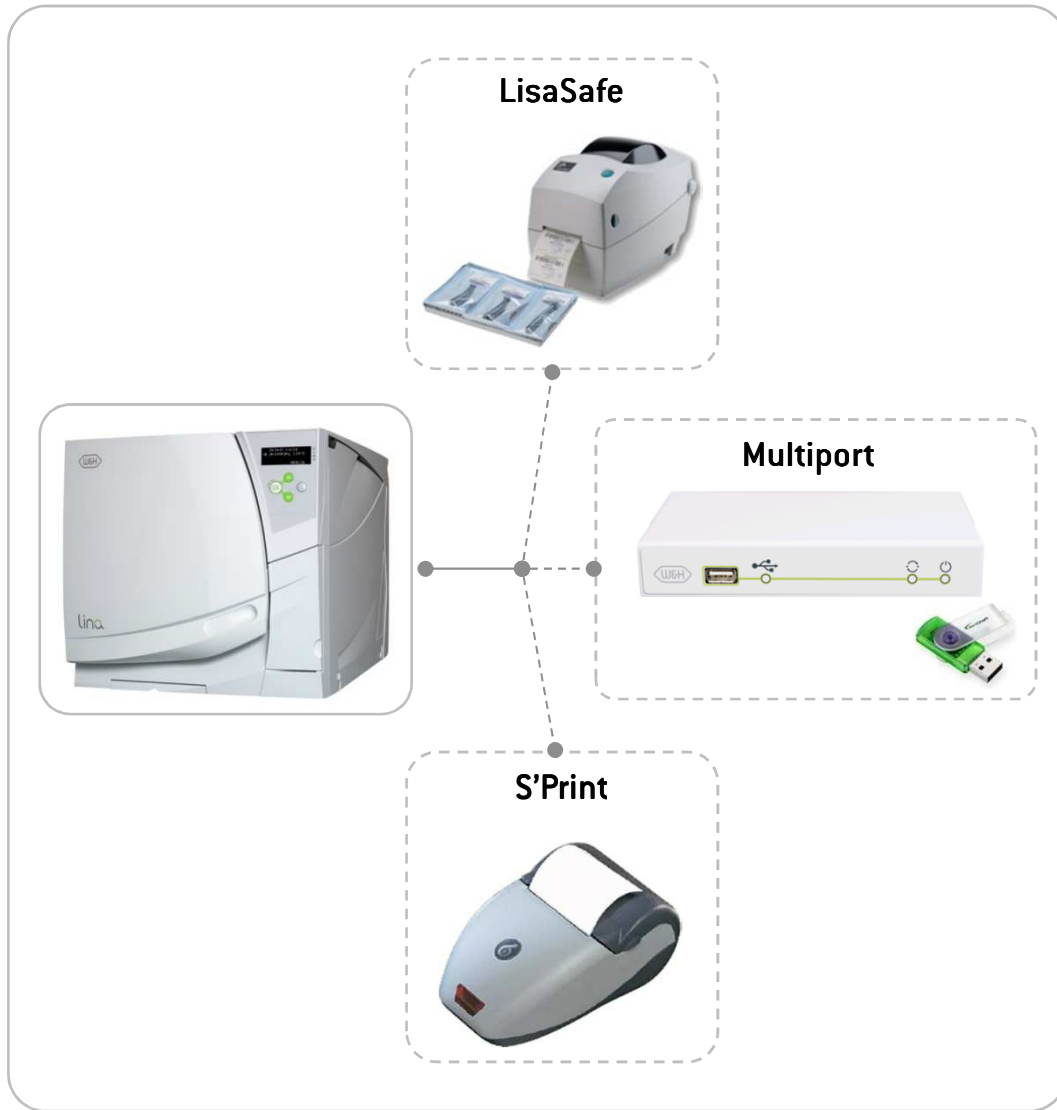

Accessory connection scheme (water treatment, supply and drain)

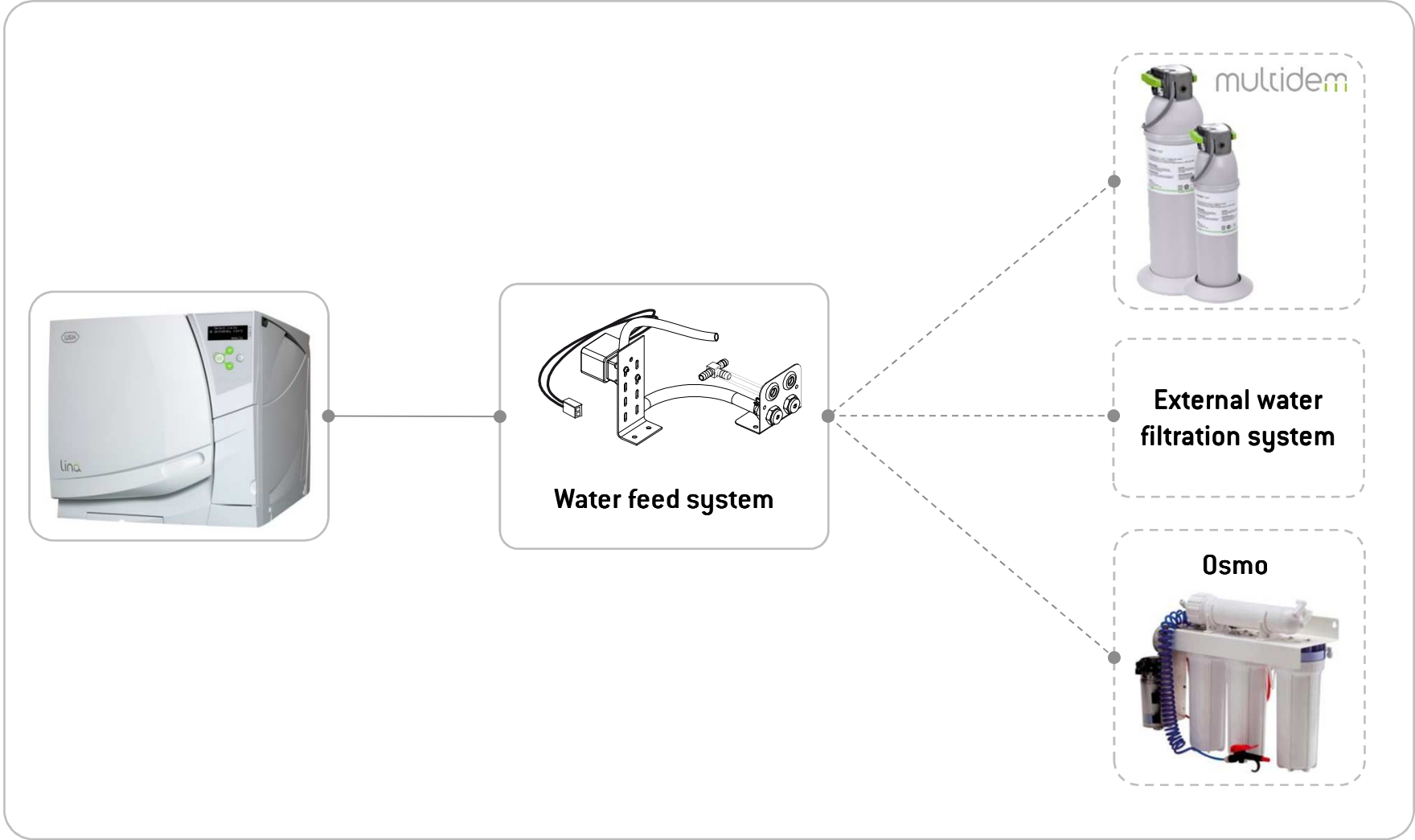

Accessories and spare parts

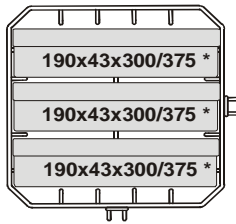
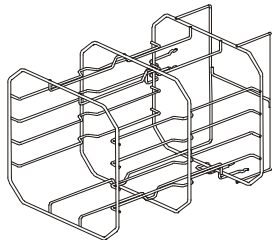

Standard chamber rack for 3 cassettes (*)
LINA MB17: part n. F523008x
LINA MB22: part n. F523009x

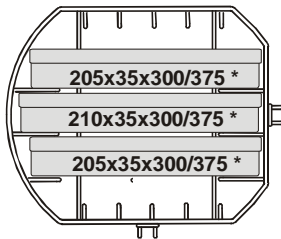
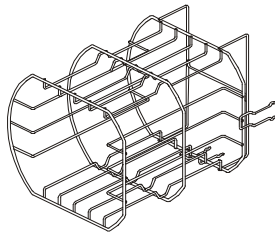

Standard chamber rack for 3 USA size cassettes (*)
LINA MB17: part n. F523020x
LINA MB22: part n. F523021x

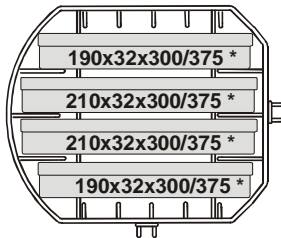
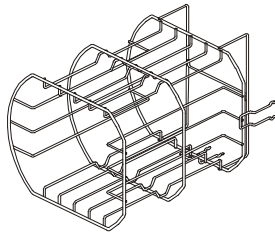

Standard chamber rack for 4 cassettes (*)
LINA MB17: part n. F523012x
LINA MB22: part n. F523015x

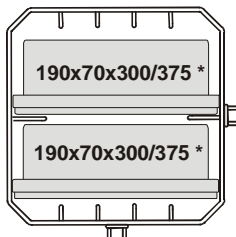
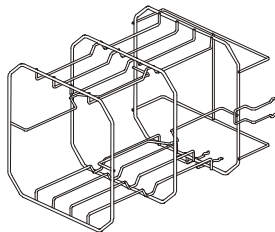

Standard chamber rack for 2 implant cassettes (*)
LINA MB17: part n. F523016x
LINA MB22: part n. F523017x

(*) All racks shown in this page, if rotated 90°, accept 5 standard aluminium trays.

Consumables

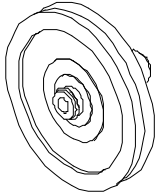

Bacteriological filter - part n. W322400x
Replace every 400 cycles

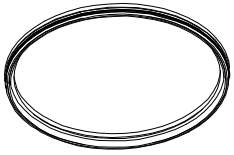

Door seal - part n. F460504x
Replace every 800 cycles

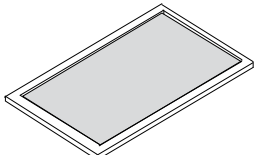

Dust filter - part n. F364502x
Replace every 400 cycles

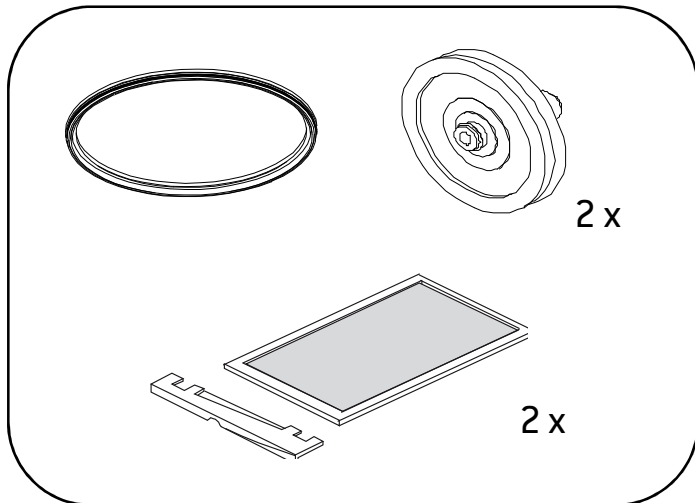

400-800 cycle consumable kit - part n. X050315x

This kit consists in a stock of consumables suitable to run 800 cycles.

It includes:

- 1 door seal;
- 2 air filters;
- 2 dust filters with handle.

APPENDIX 10. Helix test documentation form

Use this page to create a logbook tracing the effectiveness of the sterilization cycle during the whole lifespan of your sterilizer.

Date	Cycle N.	Operator	Released		Signature	Chemical indicator
			YES	NO		
			YES	NO		
			YES	NO		
			YES	NO		
			YES	NO		
			YES	NO		
			YES	NO		
			YES	NO		
			YES	NO		
			YES	NO		

Authorized W&H service partners

Find your nearest W&H service partner at <http://wh.com>

Simply go to the menu option »Service« for full details. Alternatively please contact:



W&H UK LIMITED, 6 Stroud Wood Business Centre, Park Street, St.Albans, Herts AL2 2NJ

t +44 1727 874990 f +44 1727 874628 technical.uk@wh.com



A-DEC AUSTRALIA CO.INC., Unit 8, 5-9 Ricketty Street, Mascot NSW 2020,

t +61 2 83324000 f +61 2 83324099 a-dec@a-dec.com.au



Ivoclar Vivadent NZ, P.O.Box 5243, Wellesley Street, 12 Omega Street, Auckland,

t +64 9 914 9999 f +64 9 914 9958 ivoclarvivadent@ivoclarvivadent.co.nz

Manufacturer

W&H Sterilization S.r.l.
Italy, I-24060 Brusaporto (Bg), via Bolgara, 2

t +39/035/66 63 000

f +39/035/50 96 988

wh.com

Iso 13485,
93/42 EEC – Annex II



LINA MB 201 11 ENG Rev. 3.1
Subject to alterations