

Instructions for Use



CE
0297

proxeo^{ULTRA}

PB-510, PB-520, PB-530

Contents

Symbols	4
1. Introduction	8
2. Unpacking	10
3. Scope of delivery	11
4. Safety notes	12
5. Description	18
Control unit PB-510	18
Control unit PB-520.....	19
Control unit PB-530	20
Foot control C-NF/C-NW.....	21
Status LED foot control C-NW	22
6. Start-up	23
Control unit general	23
Control unit PB-530	25
Functions control units	28
7. Operation control unit	29
Rinsing function.....	29
Cleaning function.....	30
Start-up.....	31
8. Error messages	33
9. Hygiene and maintenance	35
General notes	35
Limitations on processing.....	36
Initial treatment at the point of use	37
Manual cleaning	38
Manual disinfection	39

Contents

Inspection, maintenance and testing	40
Waterline disinfection treatment	41
10. Maintenance	42
Replacing the O-ring of the coolant tank	42
Replacing the coolant filter of the coolant hose	42
Replacing the pump cartridge	43
11. Servicing	44
12. W&H accessories and spare parts	46
13. Technical data	48
14. Data on electromagnetic compatibility according to IEC/EN 60601-1-2.....	51
15. Disposal	55
Explanation of warranty terms	56
Authorized W&H service partners.....	57

Symbols



WARNING!
[risk of injury]



CE marking with identification
number of the Notified Body



Foot control



ATTENTION!
[to prevent damage occurring]



Medical Device



Non-ionizing electromagnetic
radiation



General explanations, without
risk to persons or objects



Thermo washer disinfectable



Catalogue number



Follow Instructions for Use



Sterilizable up to the stated
temperature



Serial number



Manufacturer



Class II medical
electrical equipment



DC – direct current



Date of manufacture



Type B applied part
[not suitable for intracardiac
application]



Protection against dripping
water

Symbols

V Electric voltage (volt)



On / Off

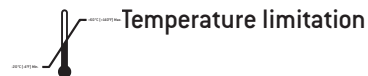

Temperature limitation

W Power (watt)



Coolant volume



Humidity limitation

Hz Frequency (hertz)



Upper limit of temperature



DataMatrix Code
for product information including
UDI (Unique Device Identification)

R

Reset



This way up



Data structure in accordance with
Health Industry Bar Code



Wireless foot control C-NW



Fragile, handle with care



“Der Grüne Punkt” (The Green
Dot) trademark of Duales System
Deutschland GmbH



ESI (External System Interface)



Keep dry



Do not dispose of with
domestic waste

Symbols



Trademark of RESY OfW GmbH for identification of recyclable transport and outer packaging of paper and cardboard



Caution! Federal law restricts this device to sale by or on the order of a physician, dentist, veterinarian or with the descriptive designation of any other practitioner licensed by the law of the State in which the practitioner practices to use or order the use of the device.



UL Component Recognition Mark indicates compliance with Canadian and U.S. requirements



MEDICAL – GENERAL MEDICAL EQUIPMENT AS TO ELECTRICAL SHOCK, FIRE AND MECHANICAL HAZARDS ONLY IN ACCORDANCE WITH ANSI/AAMI ES 60601-1:2005, ANSI/AAMI ES60601-1: A1:2012 + C1:2009/[R]2012 + A2:2010/[R]2012, CAN/CSA-C22.2 No. 60601-1:2008, CAN/CSA-C22.2 NO. 60601-1:2014. 25UX – Control No.



RCM – Australian / New Zealand



ANATEL – Brazil



[R] 209 - J00204

GITEKI (MIC) – Japan

Contains FCC ID: 00QBG113
Contains IC: 5123A-BGM113

FCC / IC – USA / Canada

1. Introduction

For your safety and the safety of your patients

These Instructions for Use explain how to use your medical device. However, we must also warn against possible hazardous situations. Your safety, the safety of your team and, of course, the safety of your patients are of paramount importance to us.



Observe the safety notes.

Intended use

PB-510, PB-520, PB-530:

Drive unit with a piezoceramic oscillating system, which moves the tip in a linear oscillation. The drive unit is used for the removal of supragingival calculus and subgingival concretions and for endodontic application and preparation of tooth enamel.

C-NF, C-NW: Foot control for operation of medical electrical equipment.



Misuse may damage the medical device and hence cause risks and hazards for user and third parties.

Qualifications of the user

We have based our development and design of the medical device on the dentists, dental hygienists, dental employees (prophylaxis) and dental assistants target group.

Introduction

Hereby, W&H declares that the medical product is in compliance with Directive 2014/53/EU (RED).

The full text of the EU declaration of conformity is available at the following internet address <https://wh.com>

Responsibility of the manufacturer

The manufacturer can only accept responsibility for the safety, reliability and performance of the medical device when it is used in compliance with the following directions:

- > The medical device must be used in accordance with these Instructions for Use.
- > Only the components approved by the manufacturer may be replaced (O-ring, coolant filter, pump cartridge).
- > Modifications or repairs must only be undertaken by an authorized W&H service partner (see page 57).
- > The medical device has no components that can be repaired by the user.
- > The electrical installation at the premises must comply with the regulations laid out in IEC 60364-7-710 (>Installation of electrical equipment in rooms used for medical purposes<<) or with the regulations applicable in your country.
- > Unauthorized opening of the medical device invalidates all claims under warranty and any other claims.

Improper use, unauthorized assembly, modification or repair to the medical device, non-compliance with our instructions or the use of accessories and spare parts which are not approved by W&H, invalidates all claims under warranty and any other claims.



Any serious incident that has occurred in relation to the medical device should be reported to the manufacturer and the competent authority!

2. Unpacking

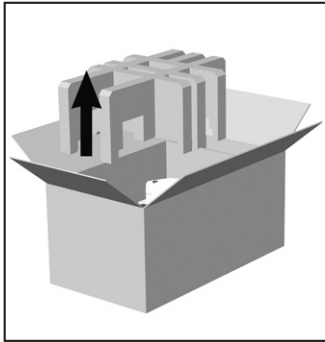

❶ Remove the insert.

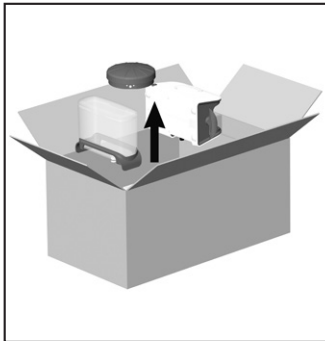

❷ Remove the control unit,
the coolant tank and
the foot control.

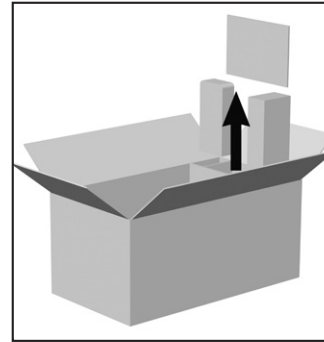

❸ Remove the Instructions for
Use and the accessories.

W&H packaging is environmentally friendly and can be disposed of by industrial recycling companies. However, we recommend that you keep the original packaging.

3. Scope of delivery

	Control unit (100–240 V)	PB-510 30323000	PB-520 30324000	PB-530 30325000
REF 02675000	Coolant filter	X		
REF 05075600	Coolant hose (Ø 6 mm, approx. 2 m)	X		
REF 08016690	Power supply with adaptor	X	X	X
REF 07991190	Coolant tank		X	X
REF 08014700	Cable (pairing/charging)			X

	Optional
REF 30316000	Foot control C-NW
REF 04717300	Foot control C-NF
REF 30326000	Handpiece PB-5 L
REF 30327000	Handpiece PB-5 L Q
REF 30328000	Handpiece PB-5 L S

4. Safety notes

Control unit/Foot control



- > Before using the medical device for the first time, store it at room temperature for 24 hours.
- > Check the medical device for damage and loose parts each time before using.
- > Do not operate the medical device if it is damaged.
- > Always ensure the correct operating conditions and cooling function.
- > Always ensure that sufficient and adequate cooling is delivered and ensure adequate suction (the exception are endodontics applications).
- > In case of coolant supply failure, the medical device must be stopped immediately.
The exception to this is in endodontic applications, where coolant is not used.
Maximum operating time without coolant:
 - > 2 minutes for the power range 1–30
 - > 30 seconds for the power range 31–40
- > Perform a test run each time before using.
- > Never touch the patient and the electrical contacts on the medical device simultaneously.
- > Check the parameter settings every time you restart.
- > Make sure that the supply hose is dry. Moisture in the supply hose can lead to a malfunction (risk of short circuit).
- > Replace damaged or leaking O-rings immediately.



- > Do not twist, kink or squeeze the supply hose (risk of damage).



The medical device is classed as »conventional equipment« (closed equipment without protection against the ingress of water).



The medical device is not approved for operation in potentially explosive atmospheres.



Disconnect the medical device in dangerous situations from the power supply.

> Pull the power supply out of the socket.



> Only use the cable supplied for the foot control [C-NW].



System failure

A total system failure does not constitute a critical fault.

Pull the power supply out of the socket and then connect again.



Hygiene and maintenance prior to initial use

> Clean and disinfect the medical device.

-  **Control unit PB-510**
- > Disconnect the medical device from the water supply connection after each use (the medical device does not have an automatic aquastop).
 - > The medical device is approved for use only with supply units with category 5 backflow prevention devices as defined in EN 1717.
 - > Do not connect the medical device to the hot water supply (>30°C/86°F).

-  **Control unit PB-520, PB-530**
- > Never fill or top up the coolant tank with liquids hotter than 30°C/86°F.
 - > Replace a faulty or leaky pump cartridge immediately.

-  The control unit is designed for use with the W&H handpiece PB-5 L/L S/L Q so only this is to be used with the control unit. The use of other handpieces could lead to a malfunction or destruction of the electronics.



Control unit PB-510, PB-520, PB-530

Risks due to electromagnetic fields

The functionality of implantable systems, such as cardiac pacemakers and implantable cardioverter defibrillator (ICD) can be affected by electric, magnetic and electromagnetic fields. This medical device is suitable for use on patients with unipolar and bipolar pacemakers or ICD, if a safety distance between the medical device and the cardiac pacemaker or ICD of at least 10 cm (3.94 inch) is maintained.

- > Find out if patient or user have implanted systems before using the medical device and consider the application.
- > Weigh the risks and benefits.
- > Make appropriate emergency precautions and take immediate action on any signs of ill-health.
- > Symptoms such as raised heartbeat, irregular pulse and dizziness can be signs of a problem with a cardiac pacemaker or ICD.



- > Keep the foot control (C-NW) away from magnetic fields.
- > Replace the foot control as soon as the resistance is noticeably reduced.



- > Do not expose the medical device to any violent mechanical impacts.

Battery (C-NW)



- > Do not charge the battery unattended.
- > As soon as the charging cycles start to deteriorate send the medical device to an authorized W&H service partner.
- > Defective or worn-out batteries must only be replaced by an authorized W&H service partner.



- > Charge the battery of the foot control as soon as the status LED flashes.
- > Incorrect use of the rechargeable battery can cause fire or corrosion.



Foot control C-NW, C-NF

Risks due to electromagnetic fields

The functionality of implantable systems, such as cardiac pacemakers and implantable cardioverter defibrillator (ICD) can be affected by electric, magnetic and electromagnetic fields.

- > Find out if patient or user have implanted systems before using the medical device and consider the application.
- > Weigh the risks and benefits.
- > Keep the medical device away from implanted systems.
- > Make appropriate emergency precautions and take immediate action on any signs of ill-health.
- > Symptoms such as raised heartbeat, irregular pulse and dizziness can be signs of a problem with a cardiac pacemaker or ICD.

5. Description

Control unit PB-510

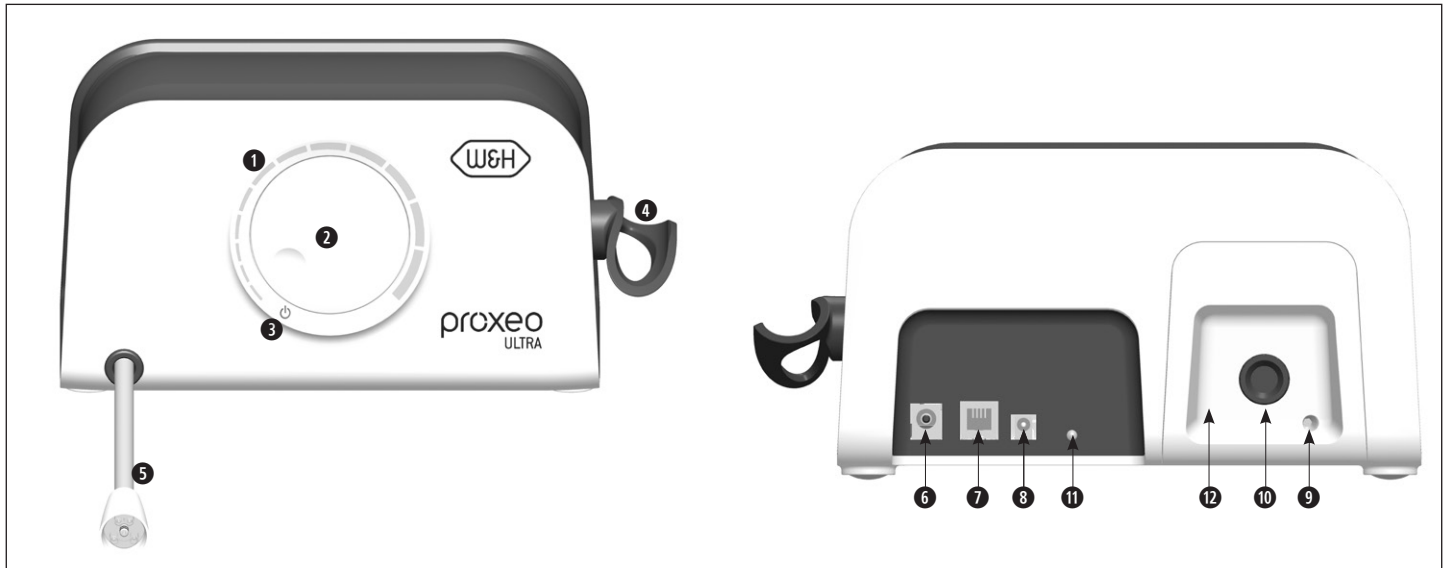

1	Power range	6	Power supply	11	Status LED
2	Power regulator	7	ESI (external service interface)	12	Cover
3	>>OFF<<	8	Foot control		
4	Handpiece support (adjustable)	9	Coolant hose		
5	Supply hose	10	Coolant regulator		

Description

Control unit PB-520

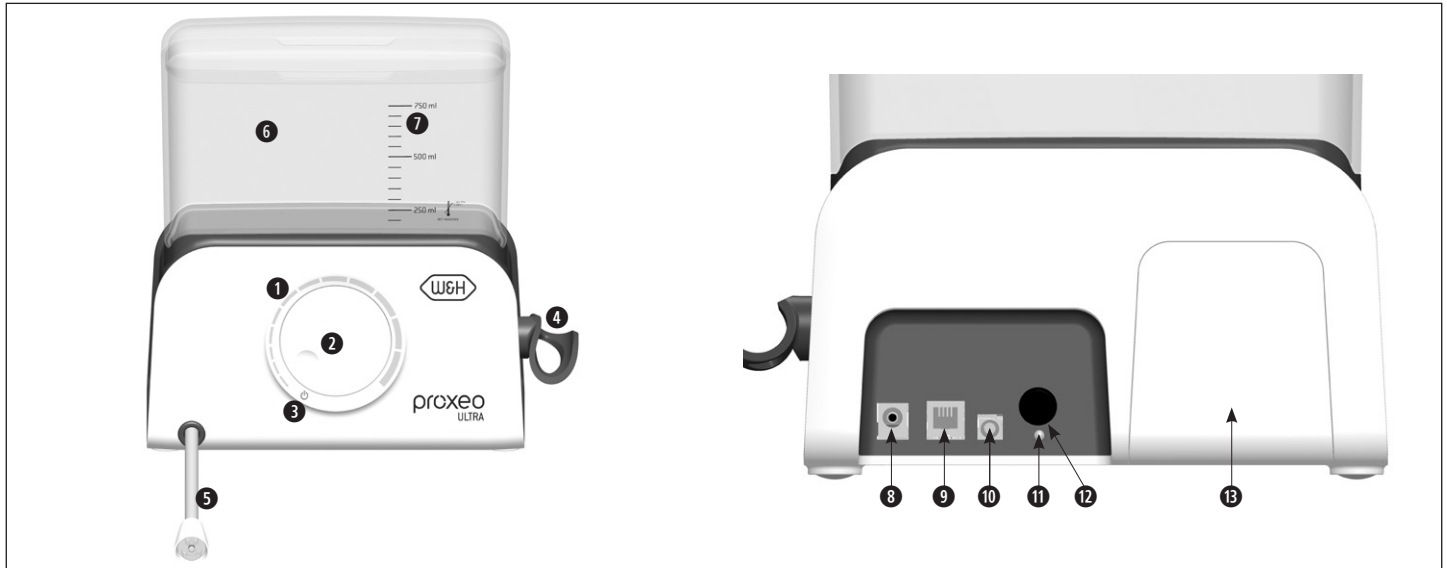

1	Power range	6	Coolant tank	11	Status LED
2	Power regulator	7	Filling level indicator	12	Coolant regulator
3	>>OFF<<	Connections		13	Cover
4	Handpiece support (adjustable)	8	Power supply		
5	Supply hose	9	ESI (external service interface)		
		10	Foot control		

Description

Control unit PB-530

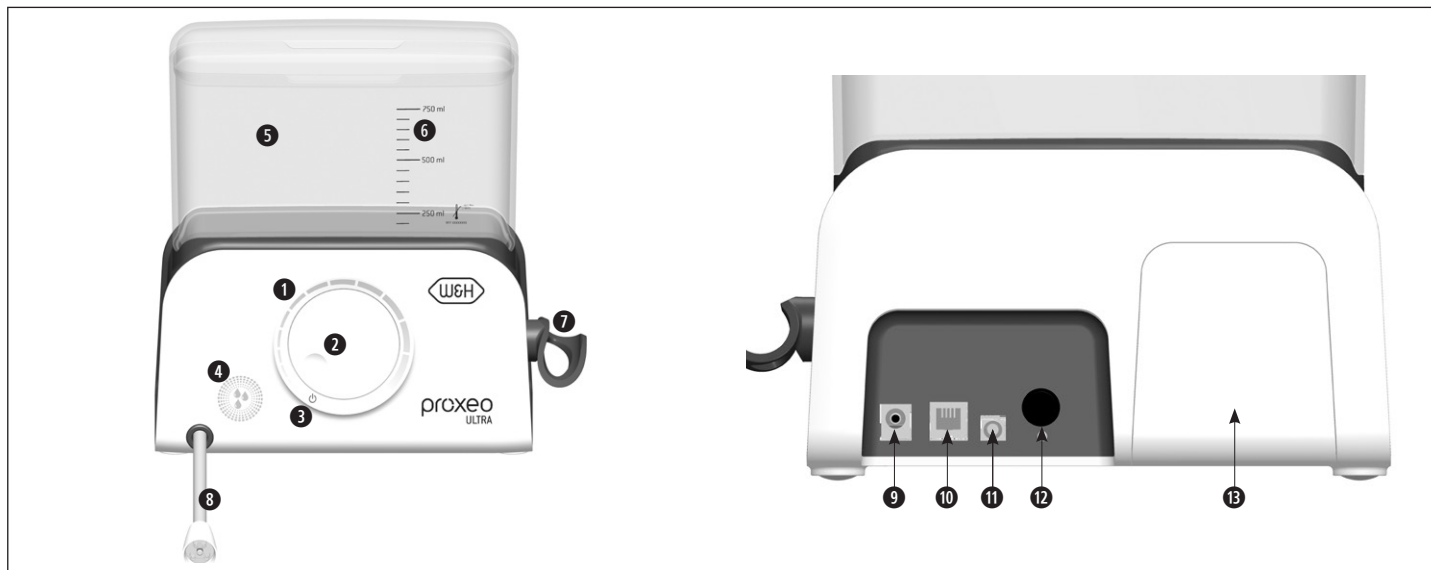

1 LED display > Power range > Battery status foot control > Error message > Rinsing function > Cleaning function > Pairing	2 Power regulator	5 Coolant tank	Connections 9 Power supply 10 ESI (external service interface) 11 Cable (pairing/charging)
	3 >>OFF<<	6 Filling level indicator	
	4 Function button > Rinsing function > Cleaning function > Pairing	7 Handpiece support (adjustable)	12 Coolant regulator
		8 Supply hose	13 Cover

Description

Foot control C-NF/C-NW

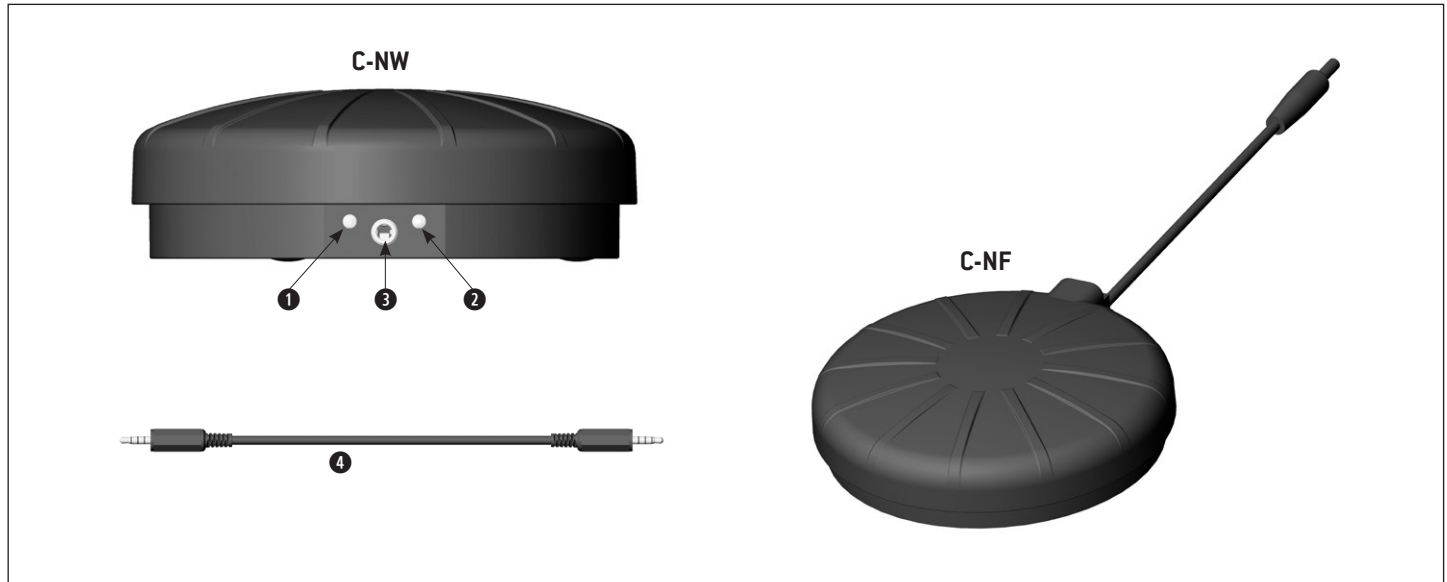

1	Charging LED (orange)
2	Status LED (green)
3	Connection for cable (pairing/charging)
4	Cable (pairing/charging)

Description

Status LED foot control C-NW



Standby mode

> The foot control can be activated by pressing.

LED	illuminated	illuminated	flashes	flashes intermittently*
GREEN		→ Connection to paired medical device established	→ Foot control is attempting to establish a connection to the paired medical device	→ Battery is flat > Charge the battery
ORANGE	→ Battery is charging			

* LED flashes for 40 milliseconds every 4 seconds

6. Start-up

Control unit general



Ensure that the medical device can be disconnected from the power supply at any time.



Place the medical device on a flat, level surface.

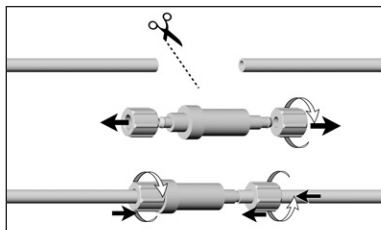

Control unit PB-510 Mount the coolant filter

- 1 Cut through the coolant hose.
- 2 Unscrew the cap nut from the coolant filter.
- 3 Attach the coolant hose through the cap nut onto the coolant filter.
Screw the cap nut tight.
- 4 Push the coolant hose until the limit stop.

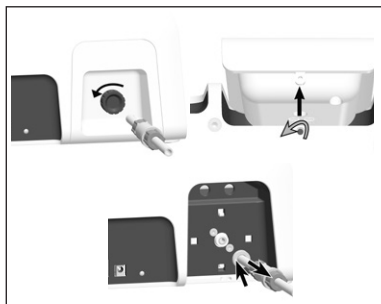
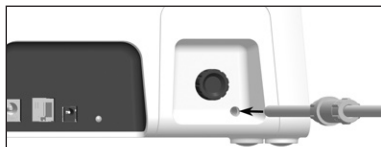

Control unit PB-510 Remove the coolant hose

- 1 Screw off the coolant regulator.
- 2 Unscrew the cover and remove it.
- 3 Push the connection ring and simultaneously remove the coolant hose.



Control unit PB-520, PB-530 Coolant tank

- 1 Fill the coolant tank and attach it. The coolant tank snaps audibly into place.

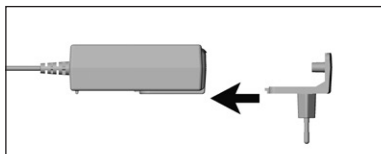

Control unit PB-510, PB-520, PB-530

- 1 Slide the adapter onto the power supply.

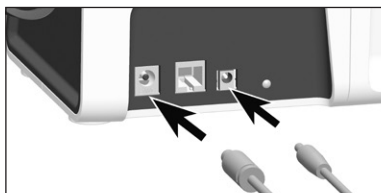

- 2 Connect the power supply.
- 3 Connect the foot control C-NF (control units PB-510, PB-520).

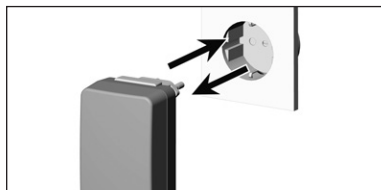

- 4 Plug the power supply into a socket.
- 5 Pull the power supply out of the socket.

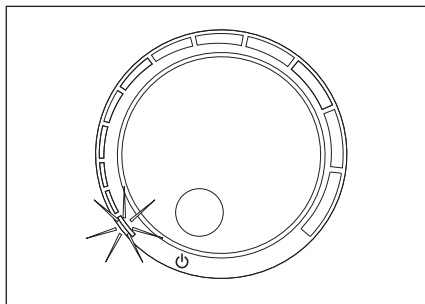

Control unit PB-530

Power regulator »OFF«

- > 1. LED flashes white

Next steps:

- > Pairing foot control C-NW with control unit PB-530
- > Charging the battery of the foot control C-NW with control unit PB-530



Coolant and handpiece inactive



The foot control C-NW and control unit PB-530 are not paired when delivered!

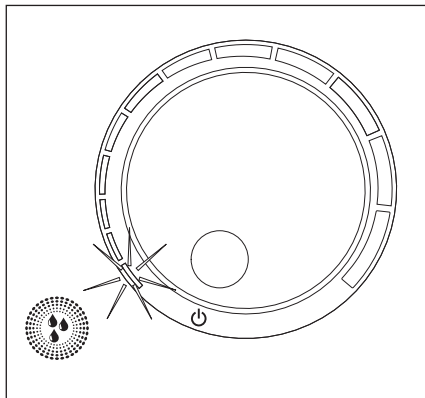

Pairing foot control C-NW with control unit PB-530

- ➊ Set power regulator to »OFF«
- ➋ Connect the cable to the control unit and foot control
 - > 1. LED flashes orange/red = not paired
- ➌ Press function button for 5 seconds
 - > Sequential white LED during pairing
 - > 1. LED flashes white = pairing successful

 Charge the foot control fully before you use it for the first time.

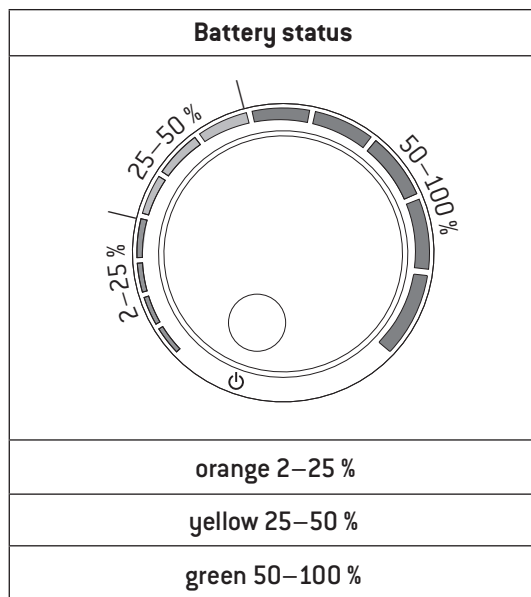

Charging foot control C-NW with control unit PB-530

- 1 Connect the cable to the control unit and foot control
 - > Power regulator »OFF«: The charging level is visible for 5 seconds at the LED display.

-  Query battery status during charging process with one of these options:
- > Press foot control, battery status visible for 5 seconds
 - > Press function button, battery status visible for 5 seconds
 - > Disconnect charging cable, battery status visible for 5 seconds
 - > Set power

- > Power set: The battery status is visible on the LED display.

-  During the charging process the LED display flashes. The LED display lights up completely when the battery is charged.

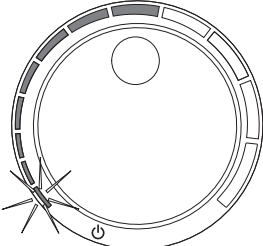
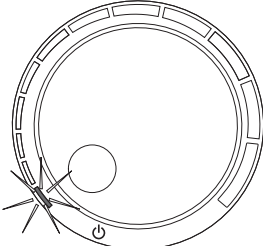

Control unit and foot control are not connected with the cable.

Indication: battery of foot control is flat	
	
<p>→ Power setting: 1. LED flashes green, remaining LEDs are lit up in green</p> <p>> Charge the battery</p>	<p>→ Power setting 0: 1. LED flashes white/blue</p> <p>> Charge the battery</p>

Proxeo Ultra	PB-510	PB-520	PB-530
Rinsing function for automatic internal cleaning of the coolant channels	✓	✓	✓
Cleaning function for automatic internal cleaning of the coolant channels	–	–	✓



Before every patient: Perform rinsing function for automatic internal cleaning of the coolant channels.

Approved coolants and rinsing liquids

- > Physiological saline solution (NaCl, 0.9%)
- > Hydrogen peroxide (H_2O_2 , 1–3%)
- > Liquids with the active substance chlorhexidine (CHX, 0.2%)
- > Tap water



W&H recommends performing a rinsing function with tap water after using one of the approved liquids.

7. Operation control unit

Rinsing function

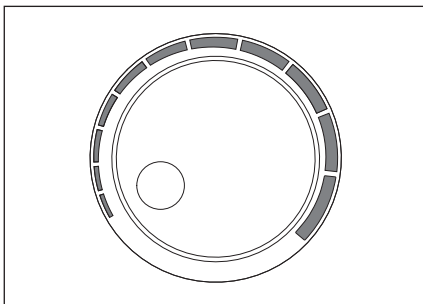

Control unit PB-510, PB-520

- ❶ Remove the handpiece from the supply
 - ❷ Set power to 0
 - ❸ Press foot control 3 times within 3 seconds
- > Rinsing function active for 30 seconds



Cancelling the rinsing function with one of these options:

- > Press foot control
- > Adjust power regulator

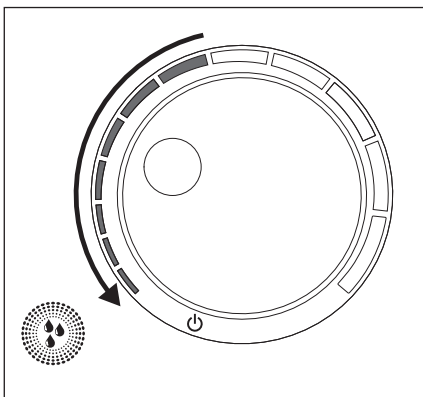

Control unit PB-530

- ❶ Remove the handpiece from the supply
 - ❷ Adjust power
 - ❸ Press function button 1 second
- > Rinsing function active for 30 seconds, visible by blue LEDs
 - > Rinsing function finished after all blue LEDs go out



Cancelling the rinsing function with one of these options:

- > Press foot control
- > Press function button 1 second
- > Set power regulator to »OFF«

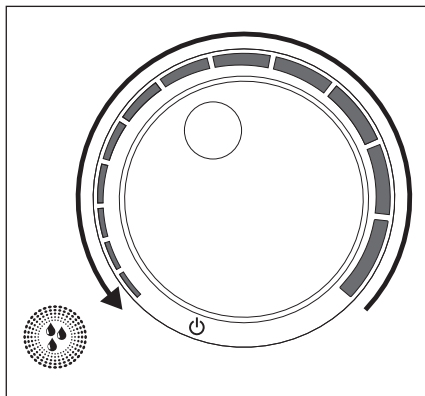

Control unit PB-530

- ❶ Remove the handpiece from the supply hose
- ❷ Set power
- ❸ Press function button 3 seconds
 - > Cleaning function active for 8 minutes, visible by blue LEDs
 - > Pump stops several times during the cleaning function
 - > Cleaning function finished after all blue LEDs go out



labelling the cleaning function with one of these options:

- > Press foot control
- > Press function button 1 second
- > Set power regulator to »OFF«

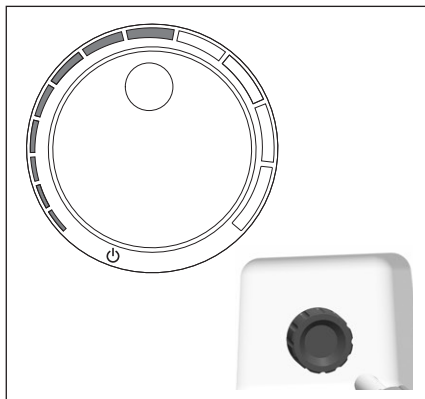

Control unit PB-510, PB-520, PB-530

- ❶ Attach the handpiece to the supply hose. Insert tip.
 Follow the directions and safety notes in the Instructions for Use of the W&H handpieces.
- ❷ Set power and coolant (variable)
- ❸ Press foot control

> Release foot control: Fade-out time of the handpiece LED 30 seconds

Control unit PB-530

> Coolant in coolant tank <50 ml: handpiece LED flashes

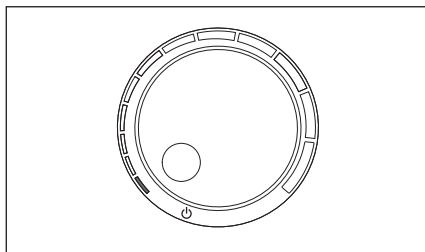

Subgingival flushing

Control unit PB-530

- ❶ Set power to 0
> 1. LED lights up in blue
- ❷ Press foot control

Test run



Do not hold the handpiece at eye level!

- > Attach the handpiece to the supply hose.
- > Insert the tip.
- > Put the medical device into operation.



In the event of operating malfunctions (e.g., vibrations, unusual noise, overheating, coolant failure or leakage) **stop the medical device immediately** and contact an authorized W&H service partner.

8. Error messages

Control unit PB-510, PB-520



The error messages are indicated at the rear of the control unit by the status LED (flashing green).

Flashing cycle	Description of error	Solution
1x	Overheating	<ul style="list-style-type: none">> Switch off control unit> Allow the control unit to cool for at least 10 minutes> Observe permissible ambient temperature/operating mode
2x	Foot control	<ul style="list-style-type: none">> Release foot control
5x	Time-out (> 15 min)	<ul style="list-style-type: none">> Release foot control (must not be active for longer than 15 minutes without interruption)
6x	Handpiece	<ul style="list-style-type: none">> Check tip (full engagement, damage, torque)> Dry the handpiece/supply hose> Check plug-in connection of the handpiece/supply hose> If the error message appears again, contact an authorized W&H service partner immediately.
8x	System error	<ul style="list-style-type: none">> Start the medical device again> Contact an authorized W&H service partner.



The error messages are indicated by the LED display (LED illuminated).

LED display	Colour	Description of error	Solution
1. LED	orange	Overheating	<ul style="list-style-type: none"> > Switch off control unit > Allow the control unit to cool for at least 10 minutes > Observe permissible ambient temperature/operating mode
2. LED	orange	Foot control	<ul style="list-style-type: none"> > Release foot control
4. LED	orange	Function button	<ul style="list-style-type: none"> > Release function button
5. LED	orange	Time-out (> 15 min)	<ul style="list-style-type: none"> > Release foot control (must not be active for longer than 15 minutes without interruption)
6. LED	orange	Handpiece	<ul style="list-style-type: none"> > Check tip (full engagement, damage, torque) > Dry the handpiece/supply hose > Check plug-in connection of the handpiece/supply hose > If the error message appears again, contact an authorized W&H service partner immediately.
12. LED	red	System error	<ul style="list-style-type: none"> > Start the medical device again > If the error message appears again, contact an authorized W&H service partner immediately.

If the error messages described cannot be resolved, a check by an authorized service partner is required.

> In case of a total system failure, switch the medical device off and on again.



Follow your local and national laws, directives, standards and guidelines for cleaning and disinfection.



- > Wear protective clothing, safety glasses, face mask and gloves.
- > Use only oil-free, filtered compressed air with a maximum operating pressure of 3 bar for manual drying.



- > The medical device is not approved for automated processing in a washer-disinfector and sterilization.



Cleaning agents and disinfectants

- > Read the notes, follow the instructions and heed the warnings provided by the manufacturers of cleaning agents and/or disinfectants.
- > Use only detergents which are intended for cleaning and/or disinfecting medical devices made of metal and plastic.
- > It is imperative to comply with the concentrations and exposure times specified by the manufacturer of the disinfectant.
- > Use disinfectants which have been tested and found effective by, for example: the Verbund für Angewandte Hygiene e.V. (VAH = Association for Applied Hygiene), the Österreichischen Gesellschaft für Hygiene, Mikrobiologie und Präventivmedizin (ÖGHMP = Austrian Society for Hygiene, Microbiology and Preventive Medicine), the Food and Drug Administration (FDA) or the U.S. Environmental Protection Agency (EPA).
- > The user is responsible for validating its process if the specified cleaning agents and disinfectants are not available.



The product lifetime and the medical device's ability to operate correctly are mainly determined by mechanical stress during use and chemical influences due to processing.

- > Send worn or damaged medical devices and/or medical devices with material changes to an authorized W&H service partner.



- > Clean the medical device immediately after every treatment.
- > Wipe the entire medical device with disinfectant.



- > Ensure that no fluids enter the medical device.



Note that the disinfectant used during pre-treatment is only for personal protection and cannot replace the disinfection step after cleaning.



> Do not place the medical device in liquid disinfectant or in an ultrasonic bath.



> Do not immerse the medical device in water or clean it under running water.

Coolant tank

- > Clean the coolant tank under running tap water [$< 35^{\circ}\text{C}$ / $< 95^{\circ}\text{F}$].
- > Rinse and brush off all internal and external surfaces.
- > Remove any liquid residues using compressed air.



W&H recommends wiping down with disinfectant.



Evidence of the medical device's basic suitability for effective manual disinfection was provided by an independent test laboratory using the disinfectants "mikrozid® AF wipes" (Schülke & Mayr GmbH, Norderstedt) and "CaviWipes™" (Metrex).



- > Check the medical device after cleaning and disinfection for damage, visible residual soiling and surface changes.
- > Reprocess any medical devices that are still soiled.

 W&H recommends performing the rinsing function (PB-520) or the cleaning function (PB-530) using an approved cleaning agent according to the manufacturer's instruction. Fill coolant tank with at least 200 ml of liquid.

Approved cleaning agents

- > Citrisil™ (Sterisil, Inc.)
- > Bilpron (ALPRO MEDICAL GMBH)

 W&H recommends performing a rinsing function with tap water after using one of the approved liquids.

10. Maintenance

Proxeo Ultra	PB-510	PB-520	PB-530
Replacing the O-ring of the coolant tank	–	✓	✓
Replacing the coolant filter of the coolant hose	✓	–	–
Replacing the pump cartridge	–	✓	✓



Replacing the O-ring of the coolant tank

- 1 Remove the O-ring with tweezers.
- 2 Slide on the new O-ring.

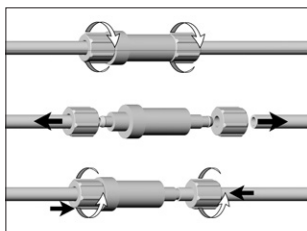

Replacing the coolant filter of the coolant hose



Replace the coolant filter if it is soiled or after 1 year at the latest.

- 1 Unscrew the cap nut from the coolant filter.
- 2 Pull off the coolant hose from the coolant filter.
- 3 Attach the coolant hose through the cap nut onto the new coolant filter. Screw the cap nut tight.

Maintenance

Replacing the pump cartridge

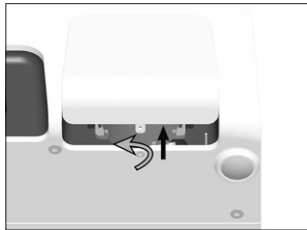

① Unscrew cover and remove.

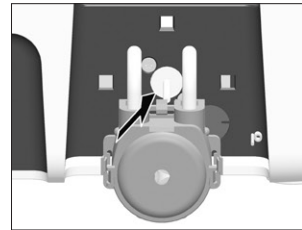

④ Attach new pump cartridge.

 Snaps audibly into place.

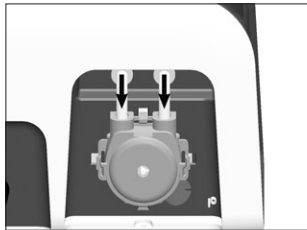

② Pull off coolant hoses.

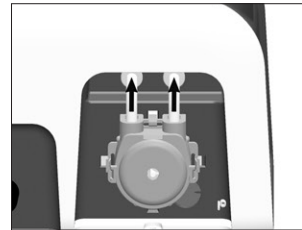

⑤ Attach the coolant hoses until the limit stop.

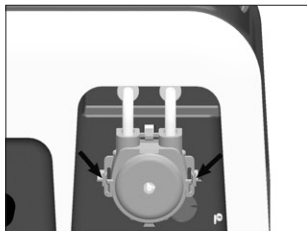

③ Unlock pump cartridge and pull it out.

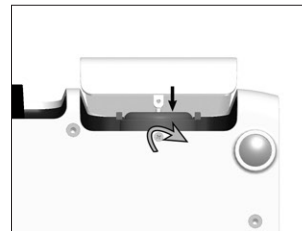

⑥ Attach cover and screw tight.

11. Servicing



Periodic inspection

Regular periodic inspection of the function and safety of the medical device is necessary and should be carried out at least once every three years, unless shorter intervals are prescribed by law.

The periodic inspection covers the complete medical device and must only be performed by an authorized service partner.

Servicing

Repairs and returns

In the event of operating malfunctions immediately contact an authorized W&H service partner.
Repairs and maintenance work must only be undertaken by an authorized W&H service partner.



> Ensure that the medical device has been completely processed before returning it.



> Always return equipment in the original packaging!

12. W&H accessories and spare parts



Use only original W&H accessories and spare parts or accessories approved by W&H.

Suppliers: W&H partners

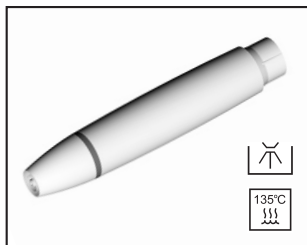

30326000

Handpiece PB-5 L

30327000

Handpiece PB-5 L Q

30328000

Handpiece PB-5 L S



02675000

Coolant filter

05075600

Coolant hose



07991190

Coolant tank

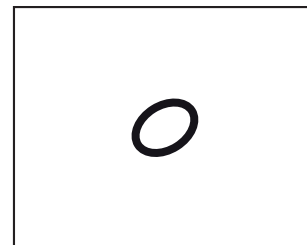

07960870

O-ring for coolant tank



08001660

Pump cartridge



08014700

Cable
[pairing/charging]



08016690

Power supply
with adaptor

W&H accessories and spare parts



30316000
Foot control C-NW
with Stick



04717300
Foot control C-NF

13. Technical data

Control unit	PB-510	PB-520	PB-530
Power supply:	28.5–31.5 V $\overline{=}$		
Mains voltage:	100–240 V		
Nominal current:	max. 830 mA		
Permissible voltage fluctuation:	±10%		
Max. output power to the handpiece under load (ultrasonic):	12 W		
Frequency (ultrasonic):	22–35 kHz		
Operating mode:	S3 (14sec/6sec)		
Max. oscillation amplitude (Tip 1U):	0.2 mm		
Max. water pressure:	1–6 bar		
Max. coolant flow (adjustable):	ca. 50 ml/min		
Dimensions in mm (WxDxH):	120 x 185 x 110	120 x 185 x 205	120 x 185 x 205
Weight:	807 g	1,064 g	1,106 g

Ambient conditions

Temperature during storage and transport:

-20°C to +60°C (-4°F to +140°F)

Humidity during storage and transport:

8% to 80% (relative), non-condensing

Temperature during operation:

+10°C to +35°C (+50°F to +95°F)

Humidity during operation:

15% to 80% (relative), non-condensing

Technical data

Foot control	C-NW
Battery type:	Li-Ion
Runtime:	approx 2 months
Standby:	automatically if not actuated
Charging time:	approx. 3 h
Nominal voltage:	3.7 V
Nominal capacity:	680 mAh
Dimensions (WxDxH):	117 x 117 x 38 mm
Weight:	190 g

Ambient conditions

Temperature during storage and transport:

-20°C to +60°C [-4°F to +140°F]

Humidity during storage and transport:

8% to 80% [relative], non-condensing

Temperature during operation:

+10°C to +35°C [+50°F to +95°F]

Humidity during operation:

15% to 80% [relative], non-condensing

Technical data

Classification according to Paragraph 6 of the General Specifications for the Safety of Medical Electrical Equipment according to IEC 60601-1/ANSI/AAMI ES 60601-1



Charger: Class II medical electrical equipment (protective earth conductor used for functional earth connection only!)



The C-NF/C-NW foot control is protected against vertically falling drops of water (IPX1 as per IEC 60529)



Type B applied part (not suitable for intracardiac application)

Pollution level:	2
Overvoltage category:	II
Altitude:	up to 3,000 m above sea level

14. Data on electromagnetic compatibility according to IEC/EN 60601-1-2

Operating environment and EMC warning notes

This medical device is neither life-sustaining nor coupled to the patient. It is suitable for operation both in domestic healthcare and in facilities used for medical purposes except rooms/areas, in which EMC interference of high-intensity may occur.

The customer and/or the user should assure that this medical device is set up and used in an environment of the specified type and/or in accordance with the specifications of the manufacturer. This medical device uses RF energy only for its internal functions. Therefore, its RF emissions are very low and not likely to cause any interference in nearby electronic equipment.

No special precautions are necessary to maintain the basic safety and essential performance of this medical device

Essential performance

This medical device has no critical functions and therefore does not have any essential performance features.

Data on electromagnetic compatibility according to IEC/EN 60601-1-2



RF communication equipment

Portable RF communications equipment (including peripherals such as antenna cables and external antennas) should be used no closer than 30 cm (11.8 inches) to the medical device. Otherwise, degradation of the performance of this medical device could result.



W&H guarantees the compliance of the device with the EMC requirements only when used with original W&H accessories and spare parts. The use of accessories and spare parts not approved by W&H can lead to an increased emission of electromagnetic interference or to a reduced resistance against electromagnetic interference.



Use of this medical device adjacent to or stacked with other equipment should be avoided because it could result in improper operation. If such use is necessary, this medical device and the other equipment should be observed to verify that they are operating normally.



The medical device is not intended for use in the vicinity of HF surgical devices.

Results of the electromagnetic tests

Requirement	Class / Test Level*
Electromagnetic emissions	
Mains terminal disturbance voltage (Conducted Emissions) CISPR 11/EN 55011 [150 kHz – 30 MHz]	Group 1 Class B
Electromagnetic radiation disturbance (Radiated Emissions) CISPR 11/EN 55011 [30 MHz – 1000 MHz]	Group 1 Class B
Harmonic distortion IEC/EN 61000-3-2	Class A
Voltage fluctuations and flicker IEC/ EN 61000-3-3	–
Immunity to electromagnetic interference	
Electrostatic discharge (ESD) IEC/EN 61000-4-2	Contact discharge: ± 8 kV Air discharge: ± 2 kV, ± 4 kV, ± 8 kV, ± 15 kV
Radiated RF electromagnetic field IEC/EN 61000-4-3 [80 MHz – 2,7 GHz]	10 V/m

Results of the electromagnetic tests

Proximity fields from RF wireless communications equipment IEC/EN 60601-1-2 Table 9 IEC/EN 61000-4-3	385 MHz	27 V/m
	450 MHz	28 V/m
	710 / 745 / 780 MHz	9 V/m
	810 / 870 / 930 MHz	28 V/m
	1720 / 1845 / 1970 MHz	28 V/m
	2450 MHz	28 V/m
	5240 / 5500 / 5785 MHz	9 V/m
Electrical fast transient/burst IEC/EN 61000-4-4 Electrical cables	±2 kV	
Surges IEC/EN 61000-4-5	-	
Conducted disturbances induced by RF fields IEC/ EN 61000-4-6	3 V 6 V in ISM bands 6 V in amateur radio bands	
Power frequency magnetic field EN 61000-4-8	30 A/m	
Voltage dips, voltage interruptions IEC/EN 61000-4-11	-	

* There are no deviations or simplifications to IEC 60601-1-2.

15. Disposal



Ensure that the parts are not contaminated on disposal.



Follow your local and national laws, directives, standards and guidelines for disposal.

- > Medical device
- > Waste electrical equipment
- > Packaging

Explanation of warranty terms

This W&H medical device has been manufactured with great care by highly qualified specialists. A wide variety of tests and controls guarantees faultless operation. Please note that claims under warranty can only be validated when all the directions in the Instructions for Use have been followed.

As the manufacturer, W&H is liable for material or manufacturing defects within a warranty period of 24 months from the date of purchase. Accessories and consumables (pump cartridge, coolant hose, coolant filter, O-rings) are excluded from the warranty.

We accept no responsibility for damage caused by incorrect handling or by repairs carried out by third parties not authorized to do so by W&H!

Claims under warranty accompanied by proof of purchase must be sent to the vendor or to an authorized W&H service partner. The provision of service under warranty extends neither the warranty period nor any other guarantee period.

24 months warranty

Authorized W&H service partners

Find your nearest authorized W&H service partner at <http://wh.com>
Simply go to the menu option »Service« for full details.

Or simply scan the QR code.



Manufacturer

W&H Dentalwerk Bürmoos GmbH
Ignaz-Glaser-Straße 53, 5111 Bürmoos, **Austria**

t +43 6274 6236-0, **f** +43 6274 6236-55
office@wh.com **wh.com**

Form-Nr. 50968 AEN
Rev. 003 / 15.03.2022
Subject to alterations